

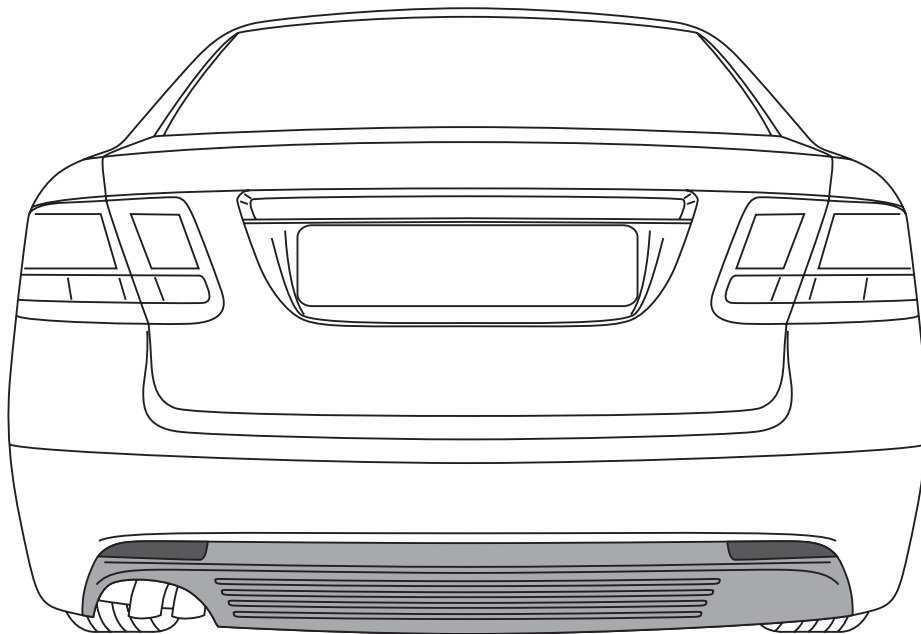

**MONTERINGSANVISNING • INSTALLATION INSTRUCTIONS
MONTAGEANLEITUNG • INSTRUCTIONS DE MONTAGE**

Accessories Part No.	Date	Instruction Part No.	Replaces
32 025 847	May 2007	32 026 187	

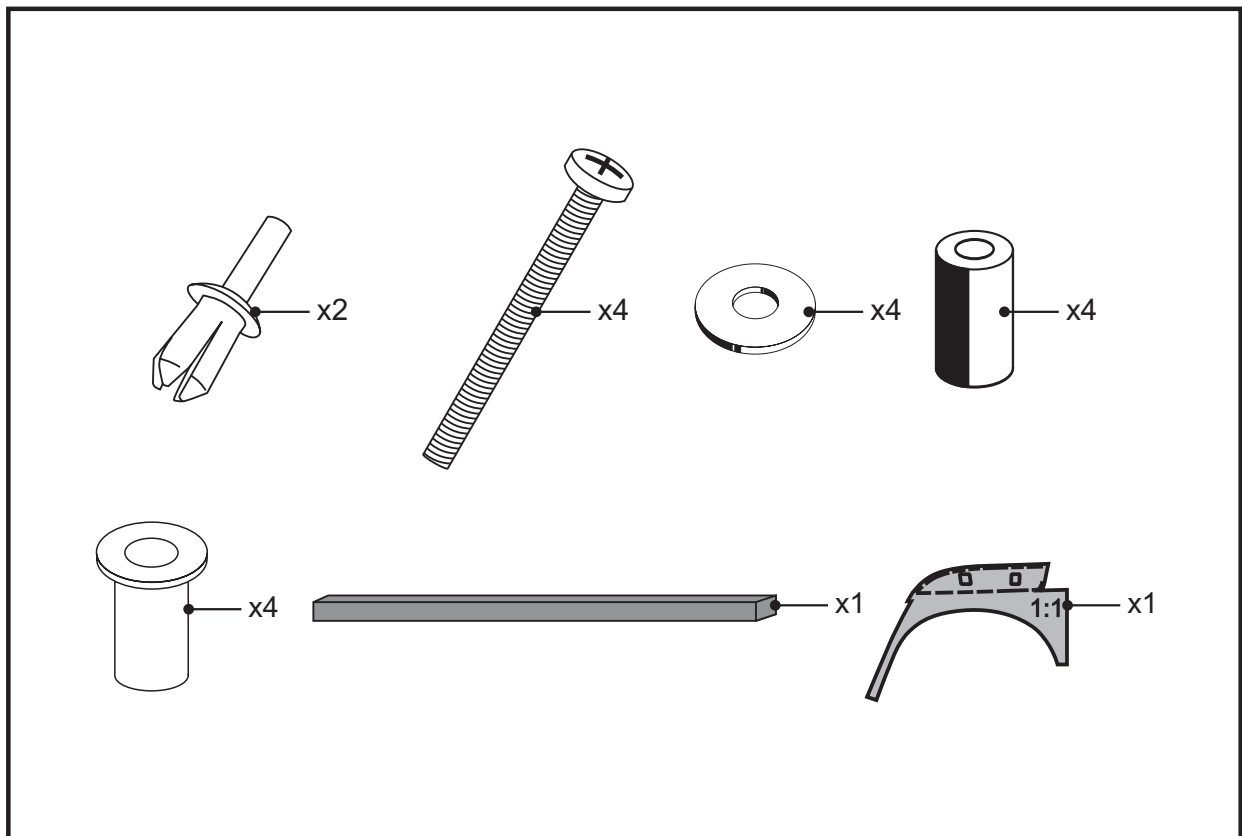

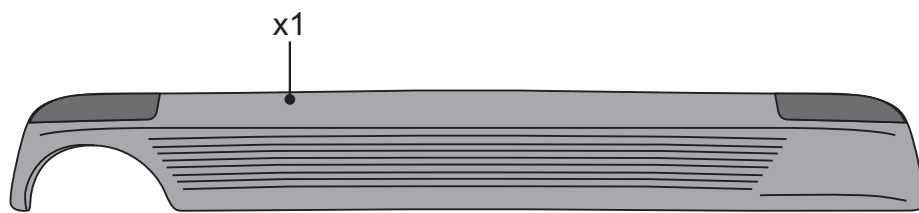

重要事项



使用附件之前请仔细阅读安装说明。

安装说明书应置于车内。

如有不确定事宜，请联络距离最近的经销商。

请勿在零件安装后5小时内驾驶车辆！

请勿在零件安装后24小时内高速行驶车辆（车速大于100km/h）！

请勿在零件安装后48小时内进行机器洗车！

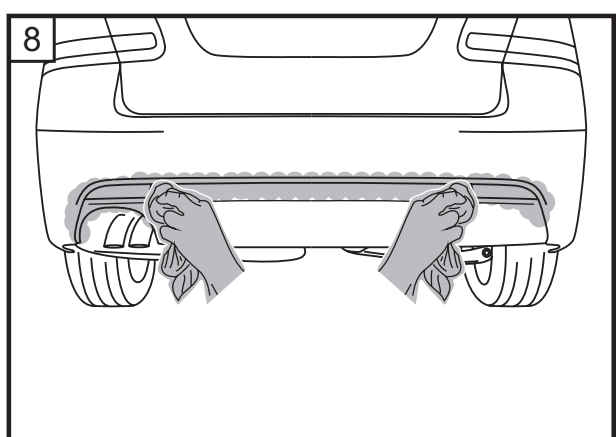
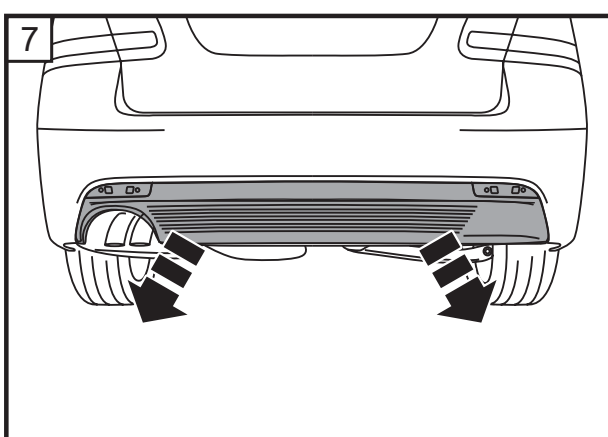
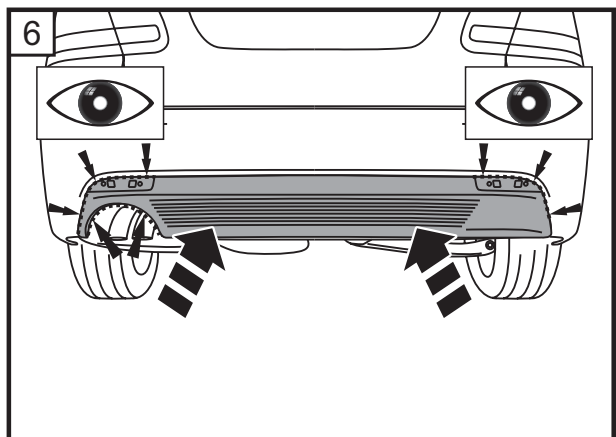
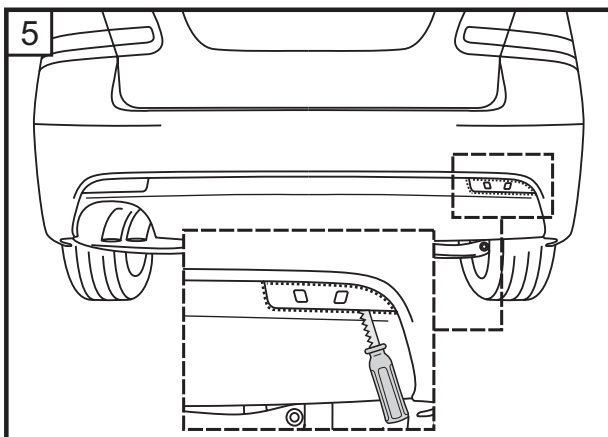
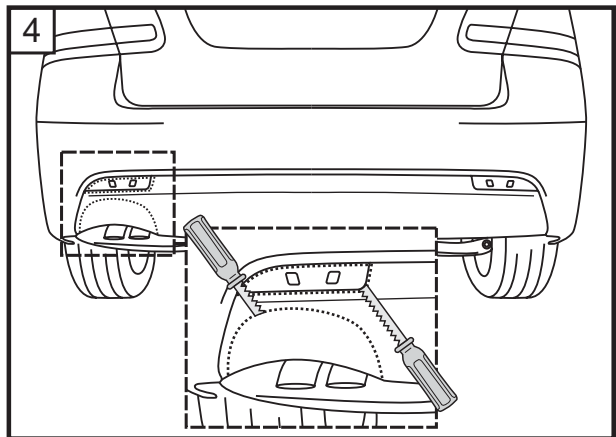
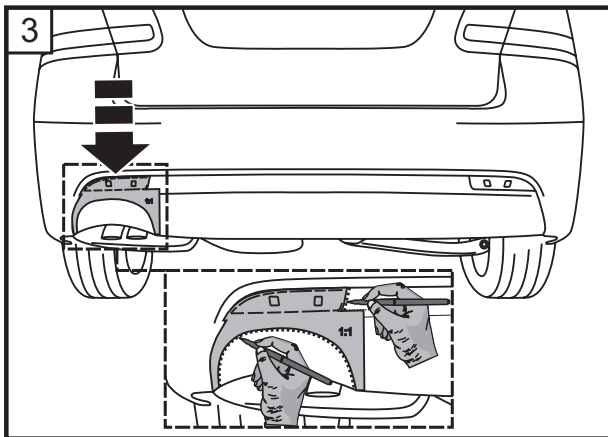
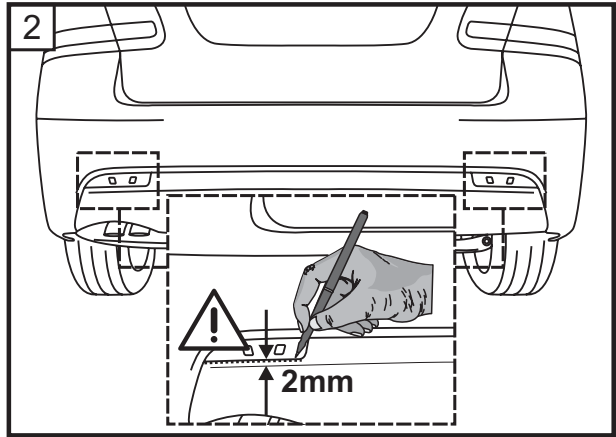
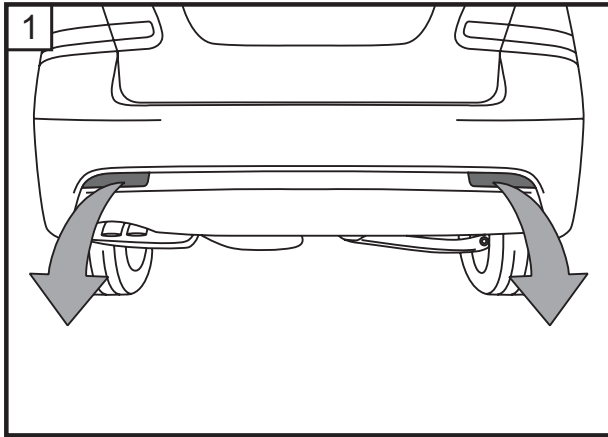

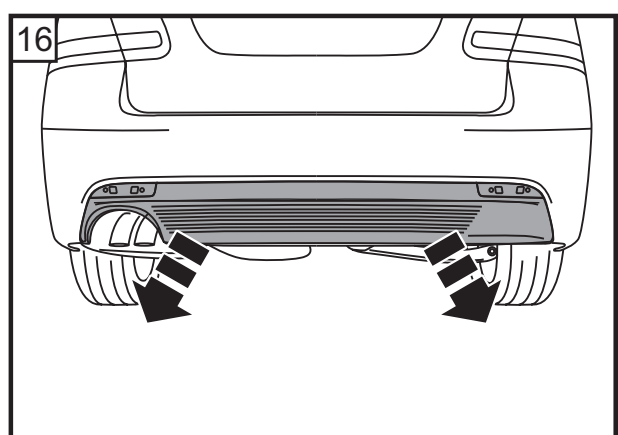
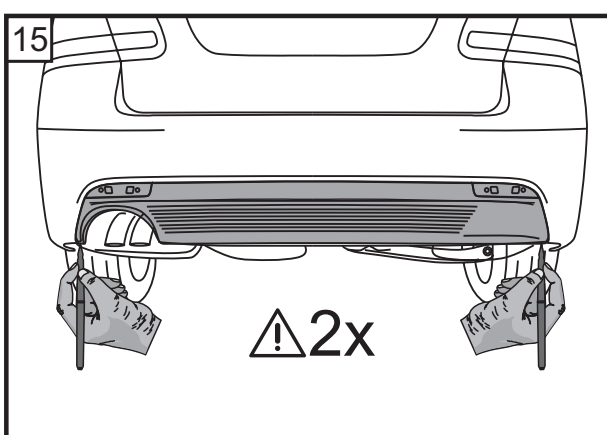
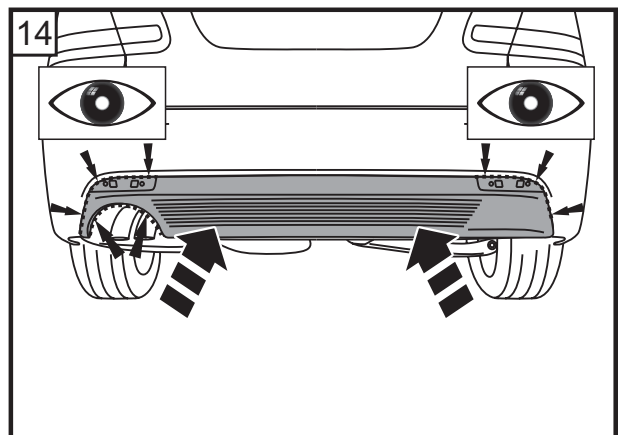
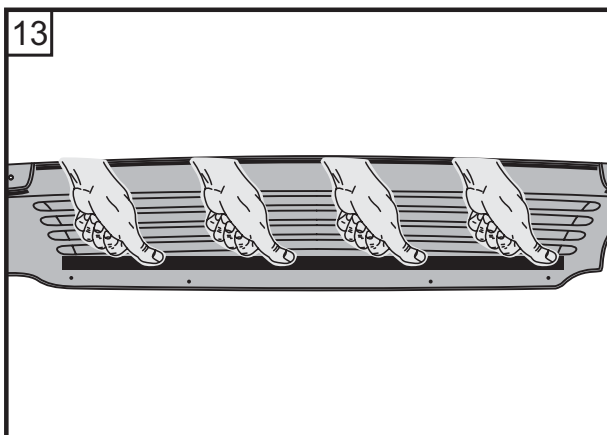
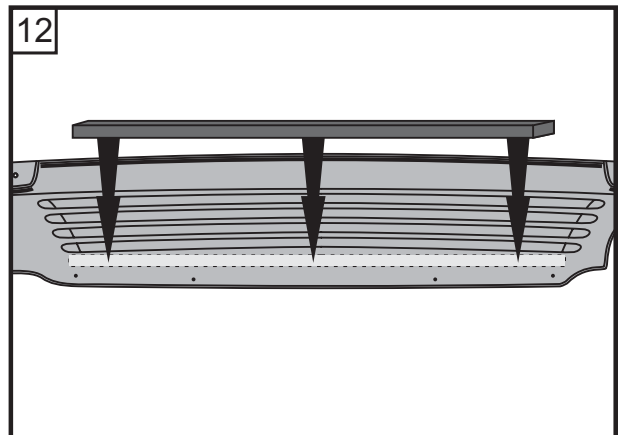
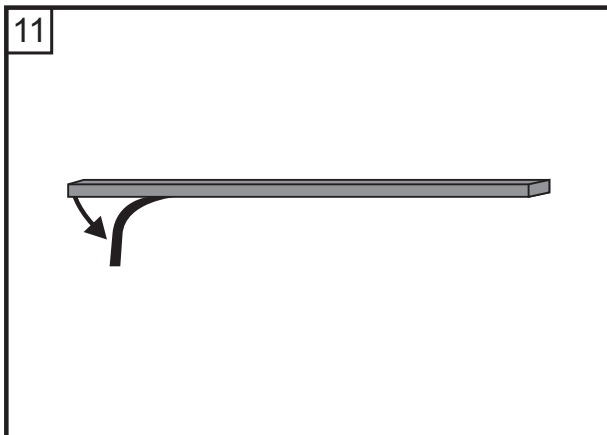
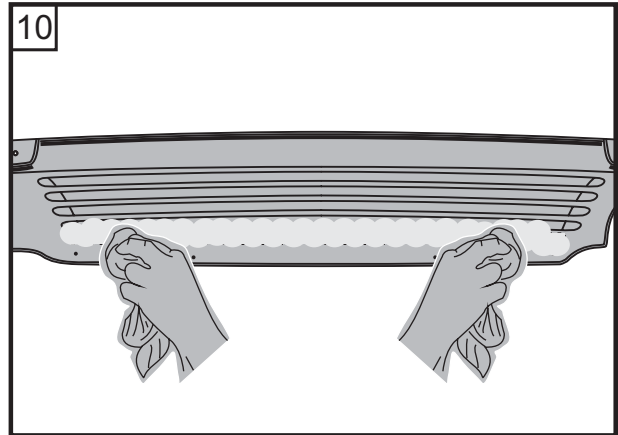
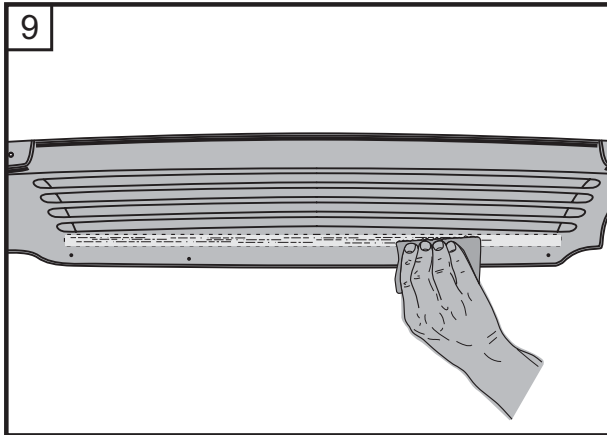

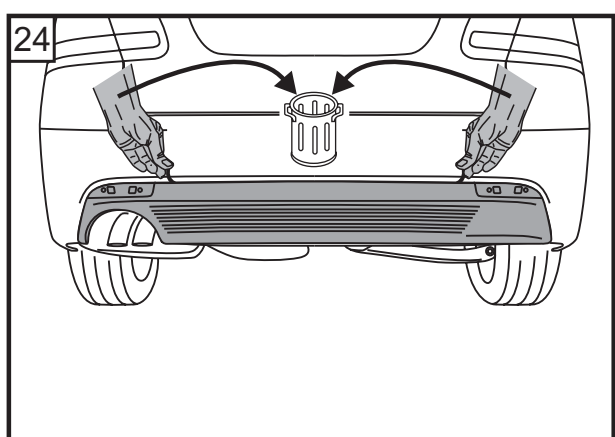
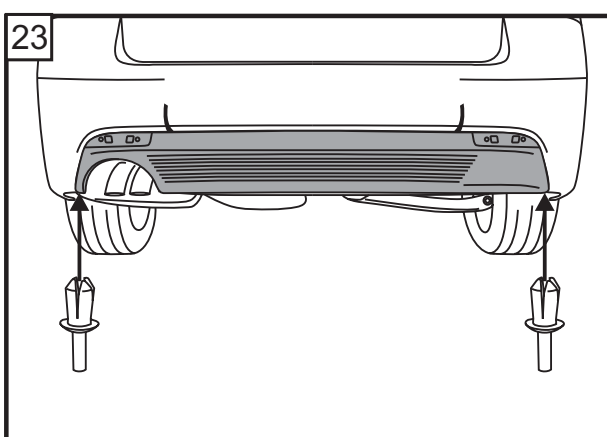
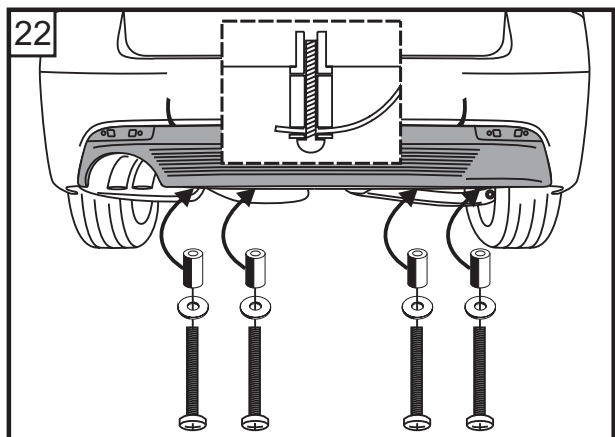
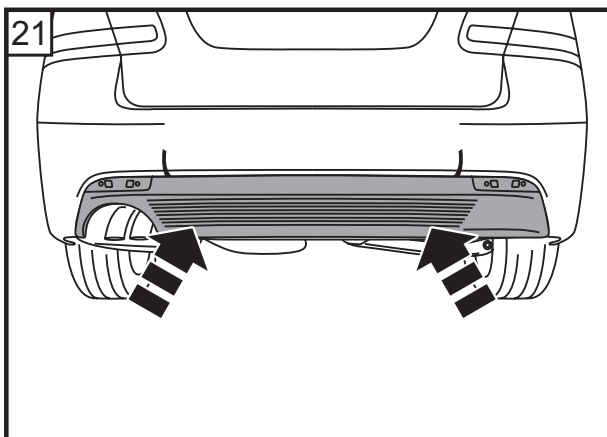
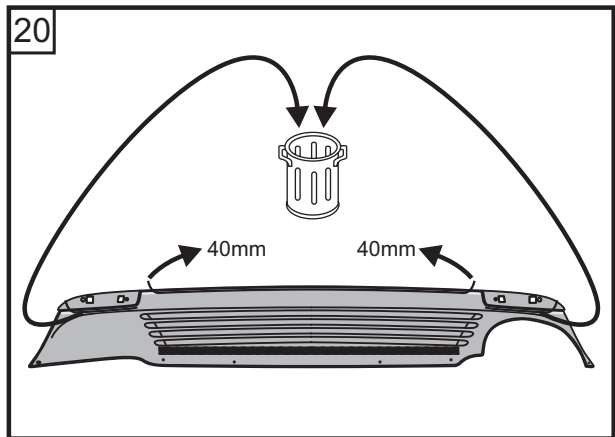
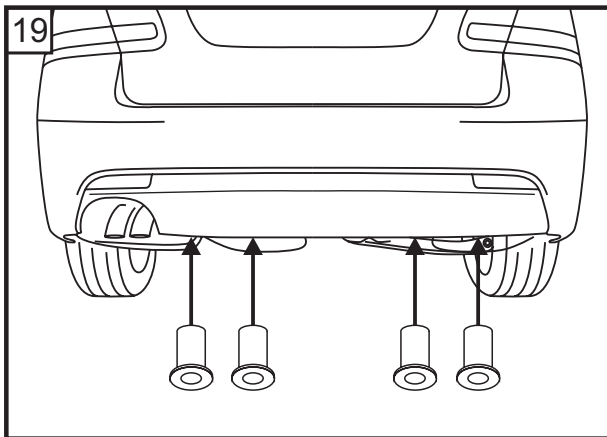
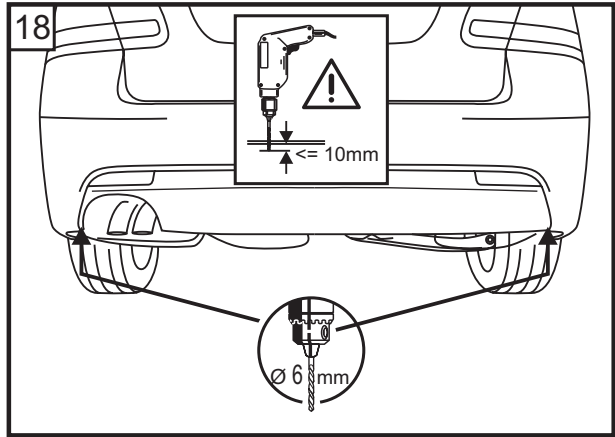
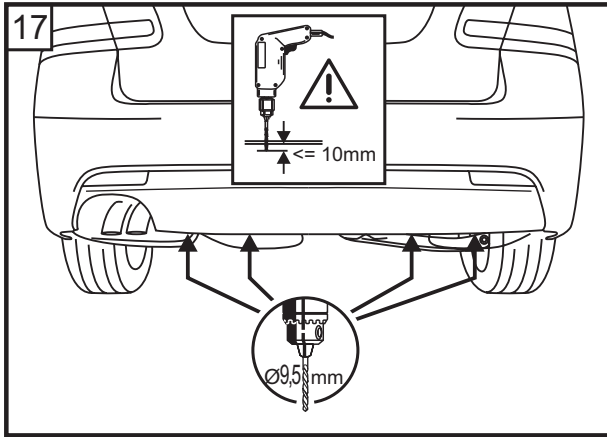

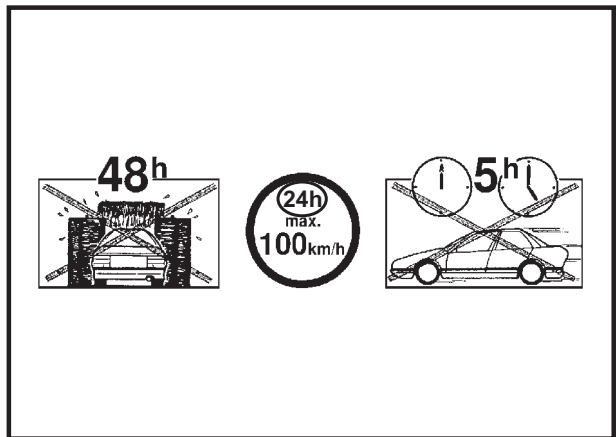
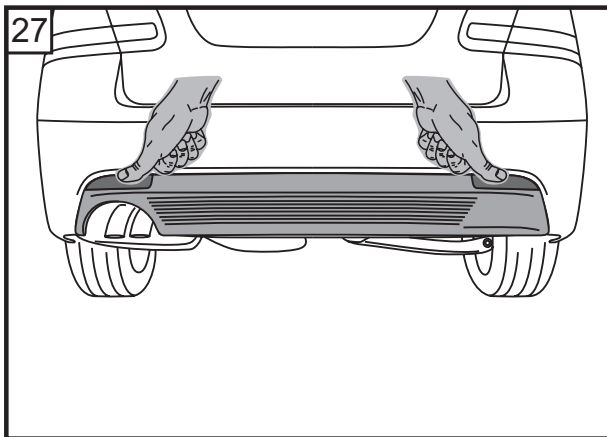
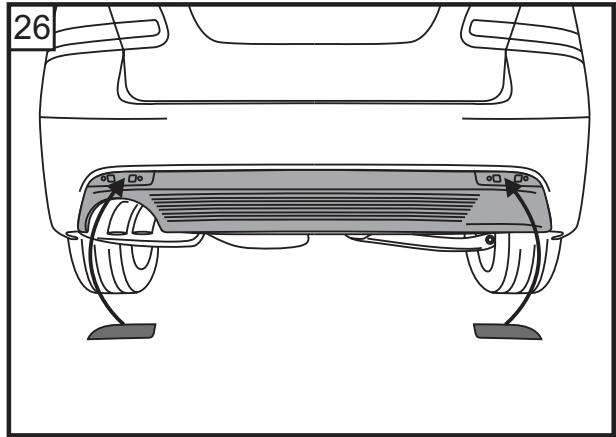
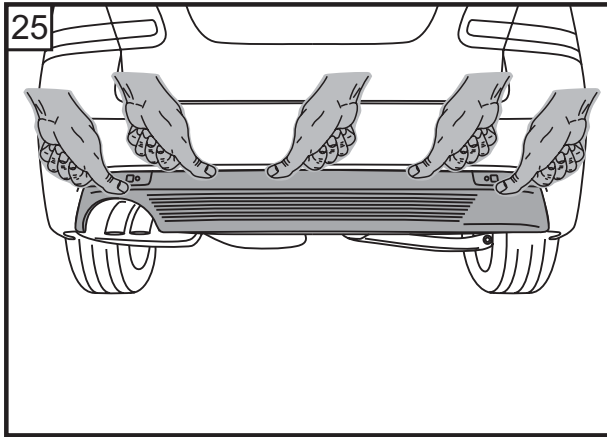





已涂有底漆部分的涂装说明

ZH		平滑地打磨已涂底漆部件 (P800-P1000)。 避免打磨底漆。
		检查瑕疵点，修整瑕疵，再平滑地打磨修整部位 (P800-P1000)。 用适当的塑料底漆再次喷涂打磨过的瑕疵点。
		用硅酮清洗剂进行彻底清洁。
		涂装过程中确保部件得到充分支撑十分重要 (存在变形的危险) ! 油漆生产厂家指定的油漆涂装与使用技巧以及厂家指定的弹性添加剂尤其重要。 材料标识应清晰地印在部件内部 (>.....<, z.B. >PUR-MF15<)。
		请勿烘烤油漆 (最高温度40°C) !