

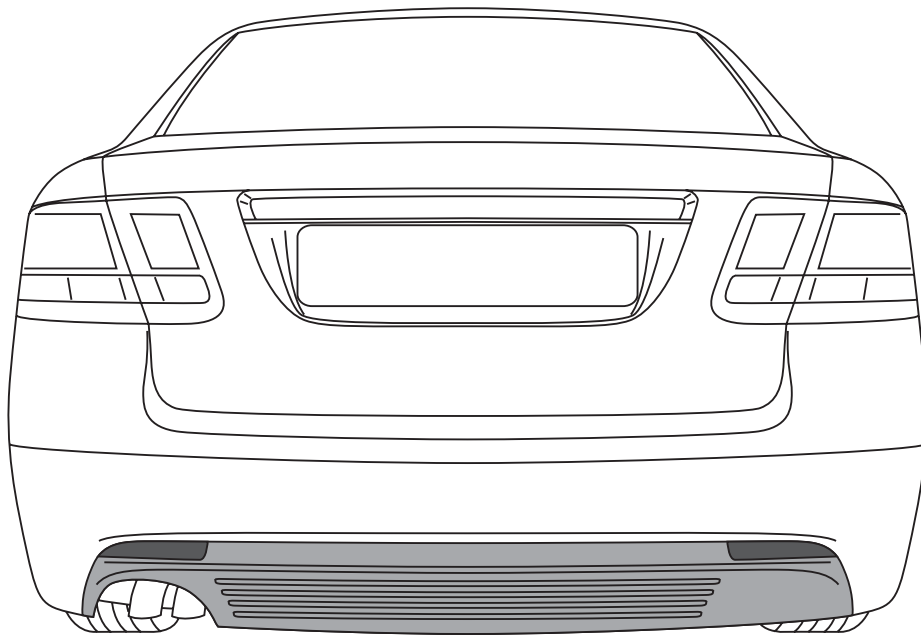

**MONTERINGSANVISNING • INSTALLATION INSTRUCTIONS  
MONTAGEANLEITUNG • INSTRUCTIONS DE MONTAGE**

Accessories Part No.	Date	Instruction Part No.	Replaces
<b>32 025 847</b>	<b>May 2007</b>	<b>32 026 187</b>	

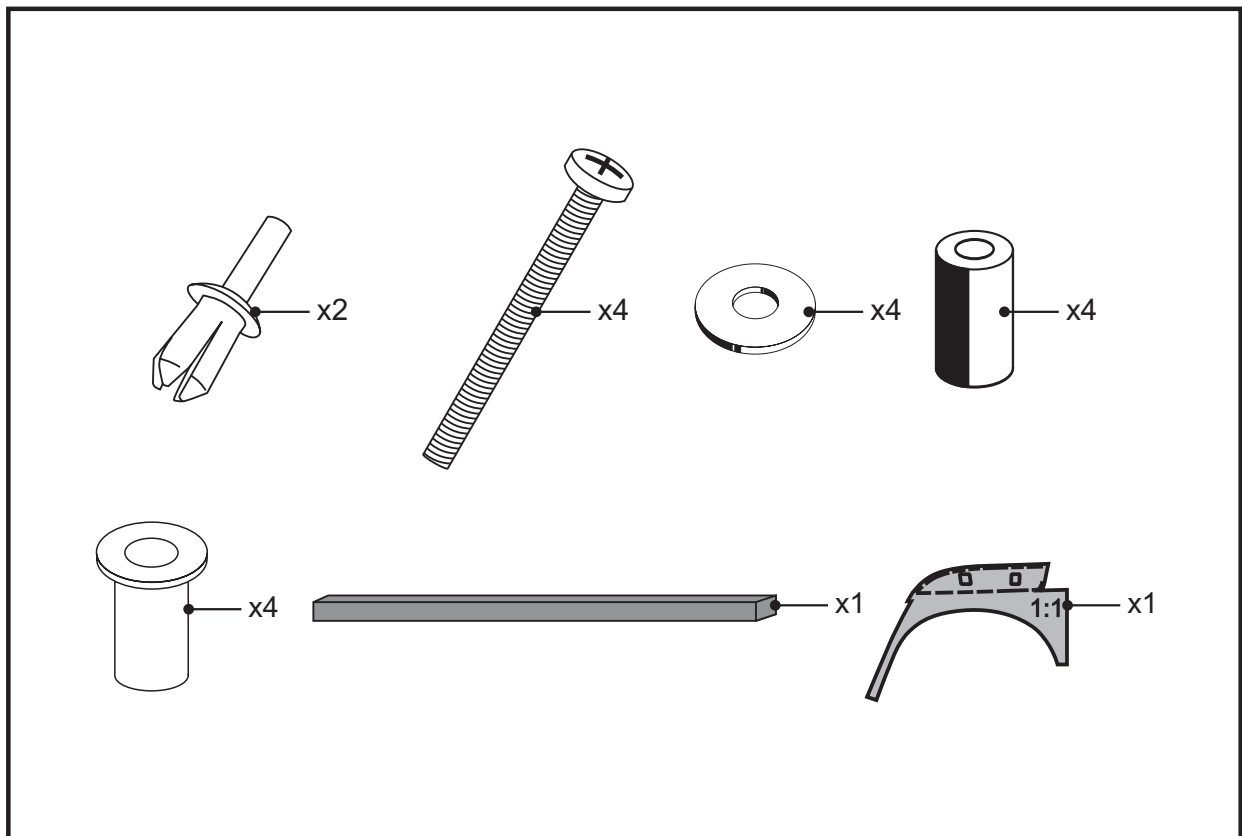

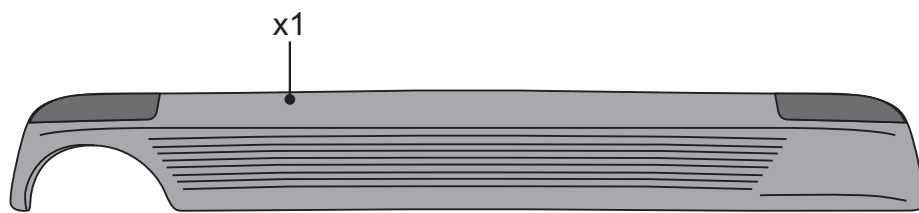

## Belangrijk

### **WAARSCHUWING**

Lees de instructies zorgvuldig voor u het accessoire gebruikt.

Deze installatie-instructies moeten in de wagen bewaard blijven.

Neem in twijfelgevallen contact op met de dichtstbijzijnde verdeler.

Rijd niet met het voertuig binnen de 5 uren na de installatie van het onderdeel!

Rijd niet aan hoge snelheid met het voertuig (niet sneller dan 100km/h) de eerste 24 uren na de installatie van het onderdeel!

Gebruik geen machinale carwash binnen de 48 uren na de installatie van het onderdeel!

---

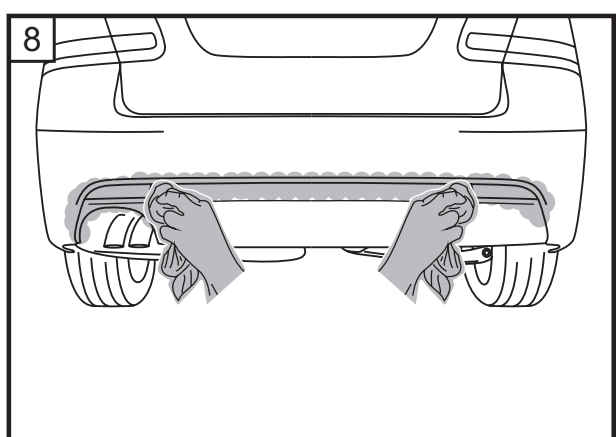
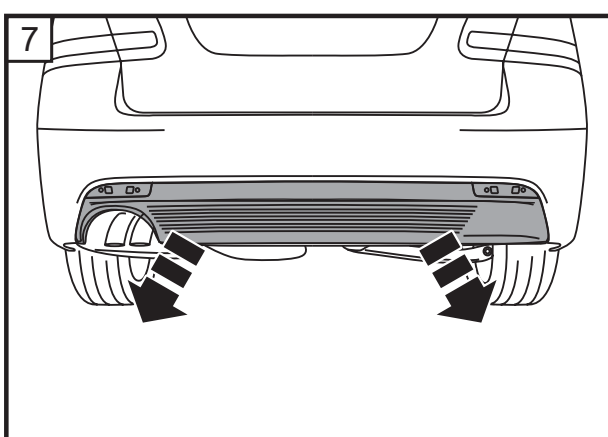
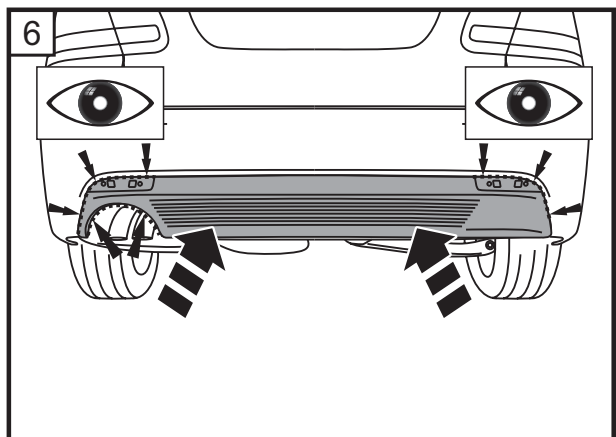
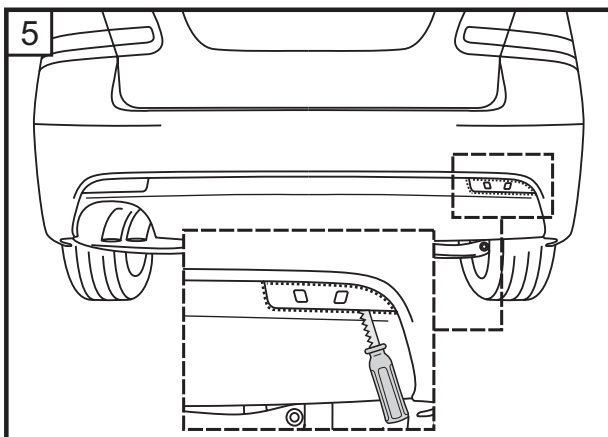
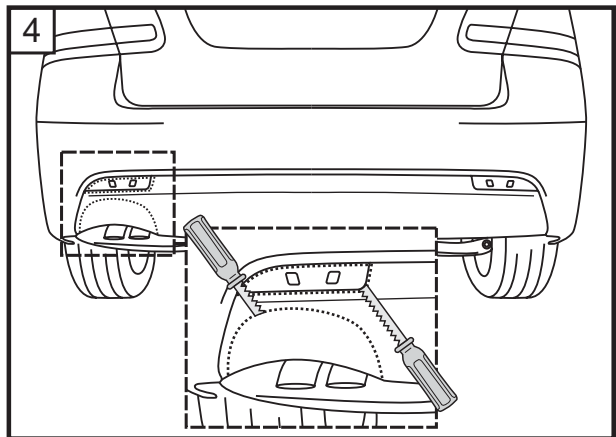
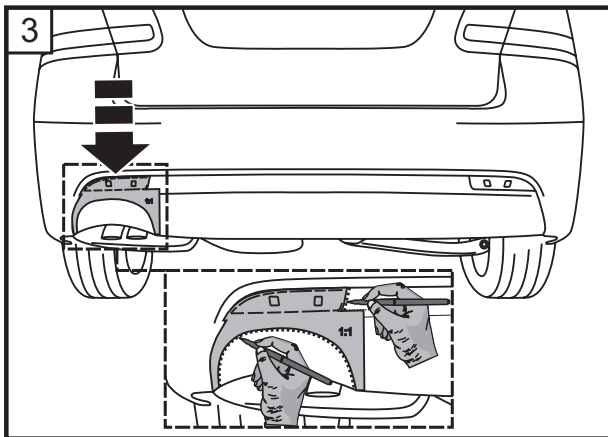
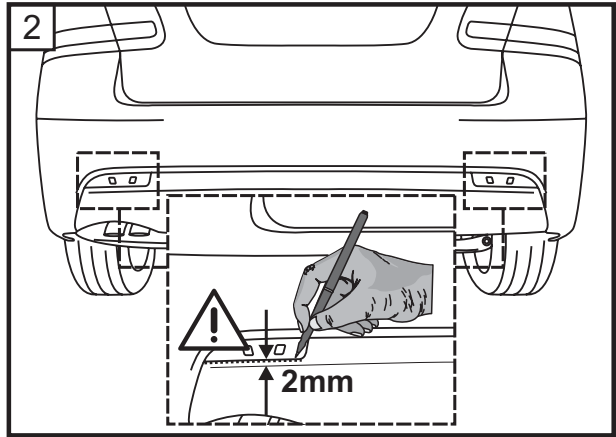
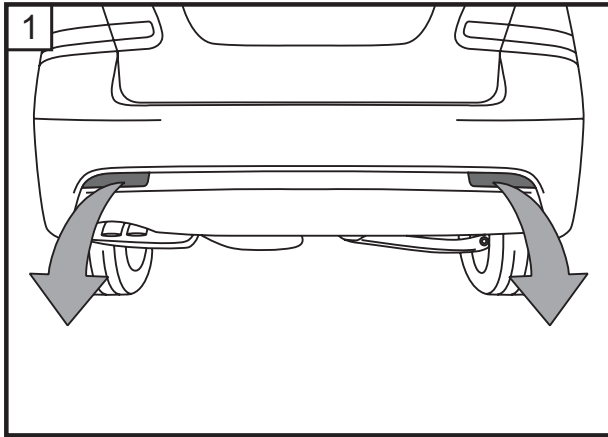

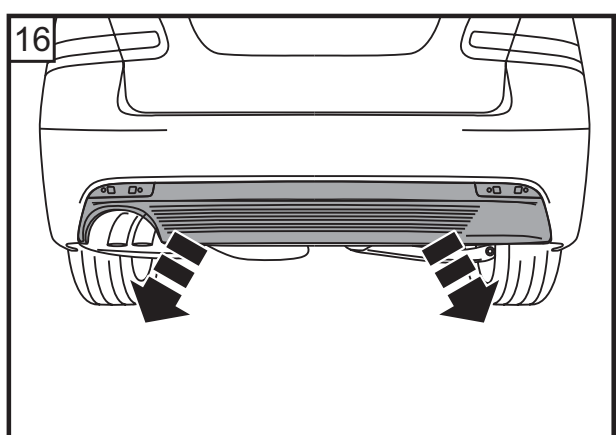
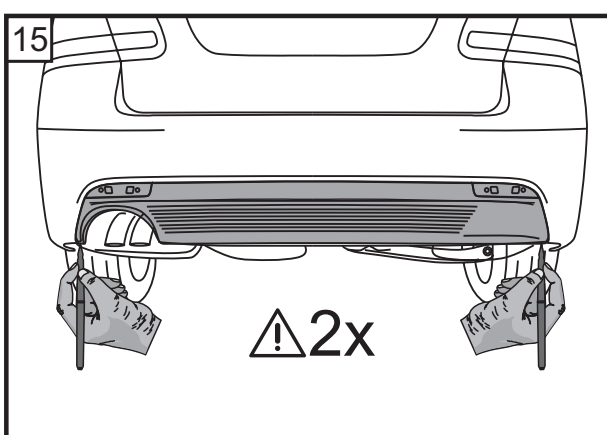
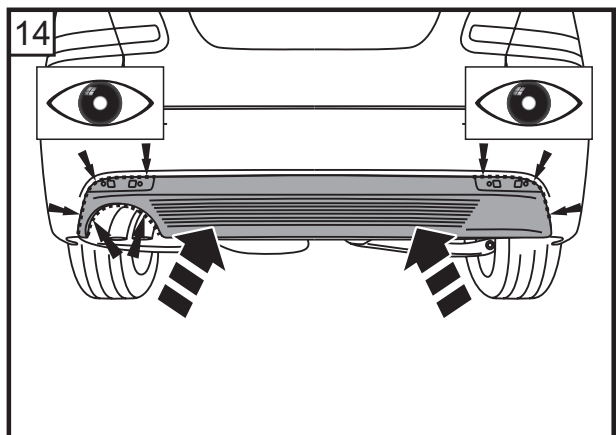
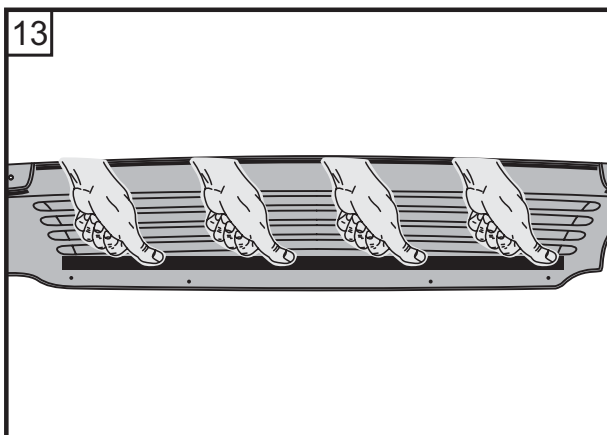
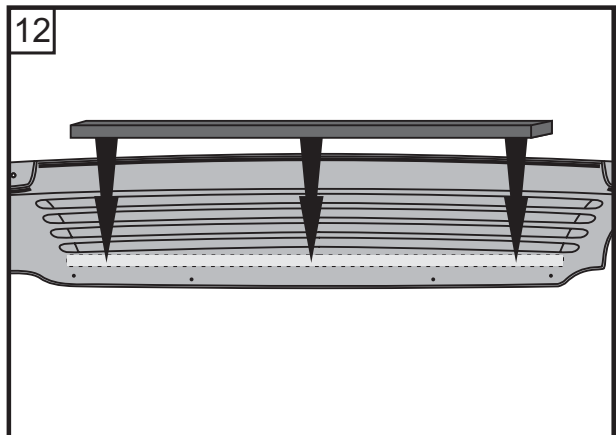
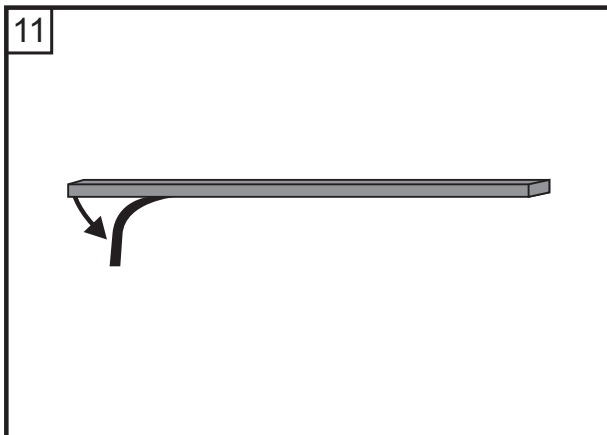
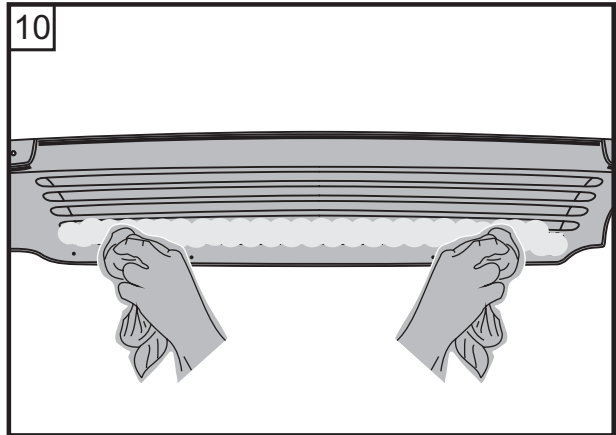
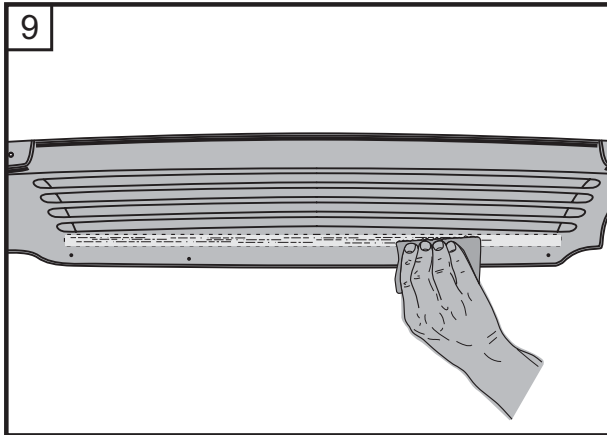

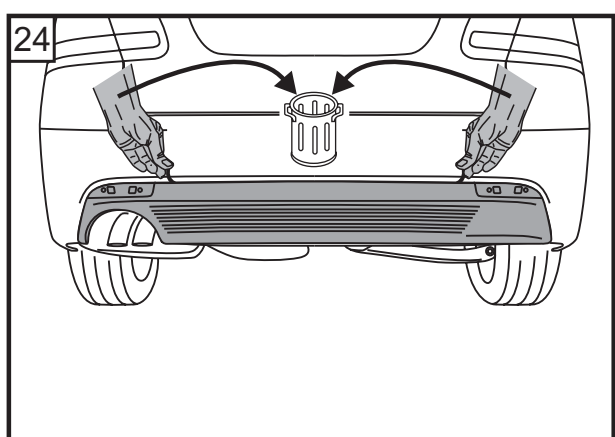
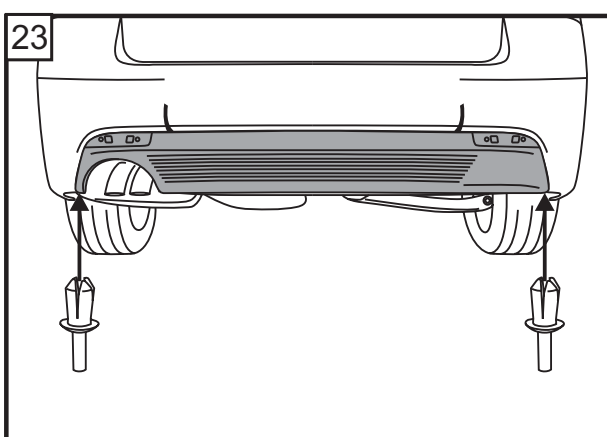
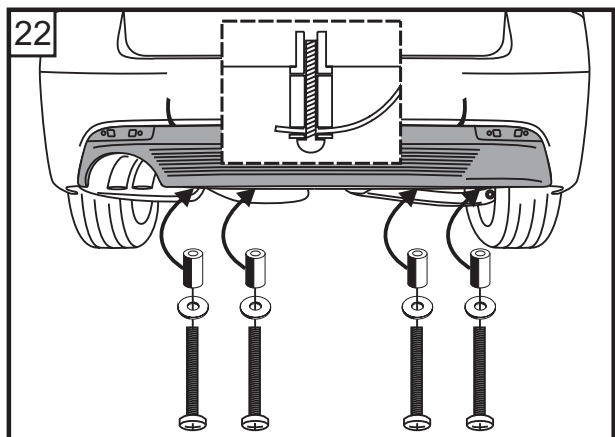
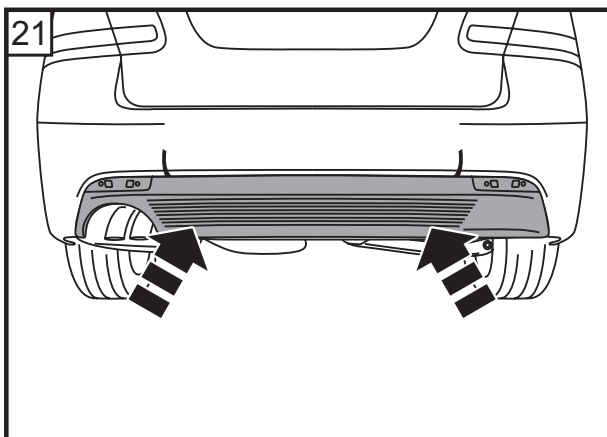
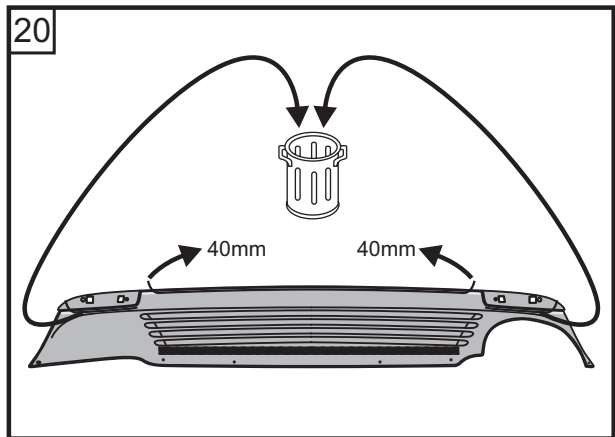
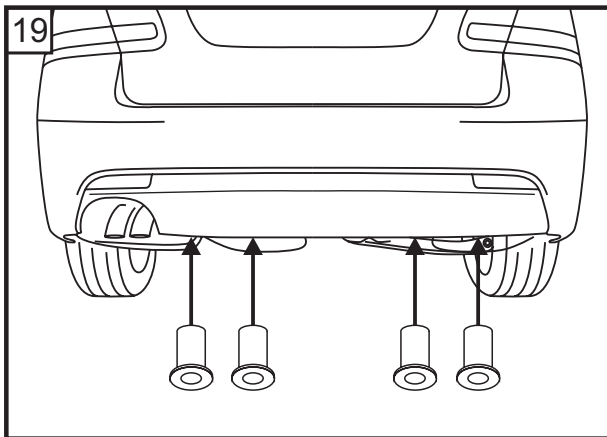
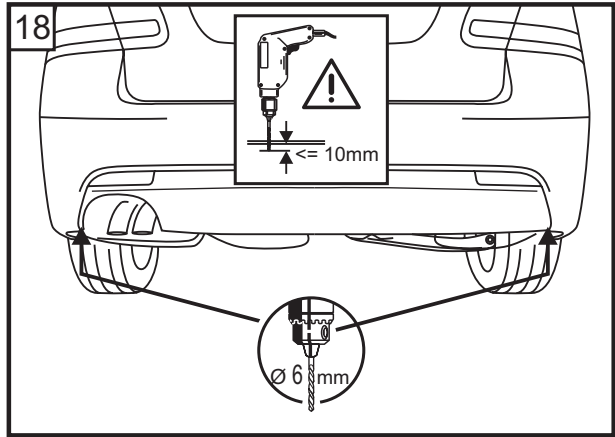
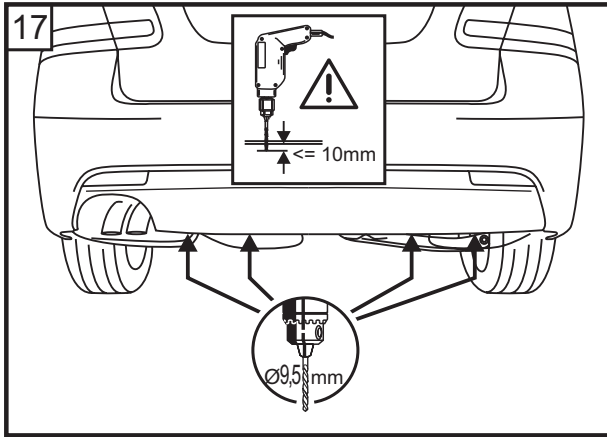

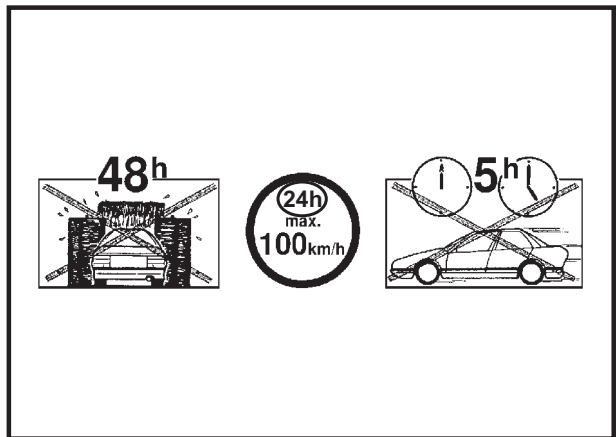
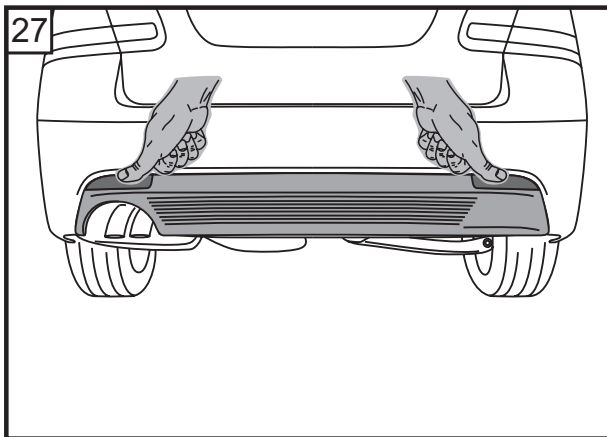
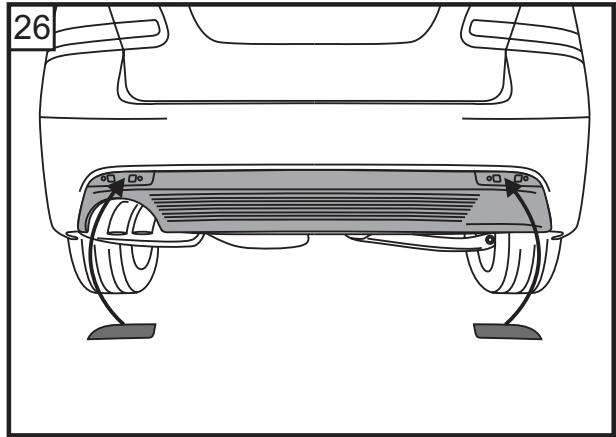
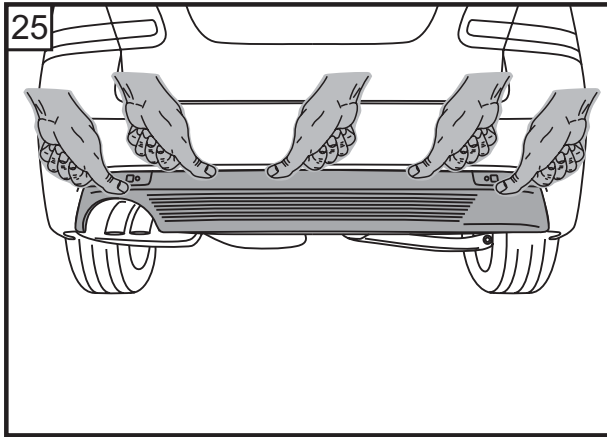





## Verfinstructies voor het onderdeel voorzien van een primerlaag

<b>DA</b>		Schuur de primerlaag licht op (P800-P1000). Vermijd door de primerlaag te schuren.
		Controleer kleine foutjes, herstel ze, en schuur de herstelling zacht op (P800-P1000). Breng op plaatsen waar de ondergrond zichtbaar is terug een geschikte plastic-primer aan.
		Grondig reinigen met een silicone-verwijderaar.
		Het is belangrijk het onderdeel voldoende te ondersteunen tijdens het verfproces (risico op vervorming)! Volg voor de opeenvolgende laagdiktes en de wijze van aanbrengen de aanwijzingen van de fabrikant. Vooral de additieven in verband met de elasticiteit, gespecificeerd door de verffabrikant, zijn bijzonder belangrijk. De omschrijving van het materiaal is zichtbaar aan de binnenzijde van het onderdeel (>.....<, bijv. >PUR-MF15<).
		<b>De verf niet bakken (maximum 40°C)!</b>