

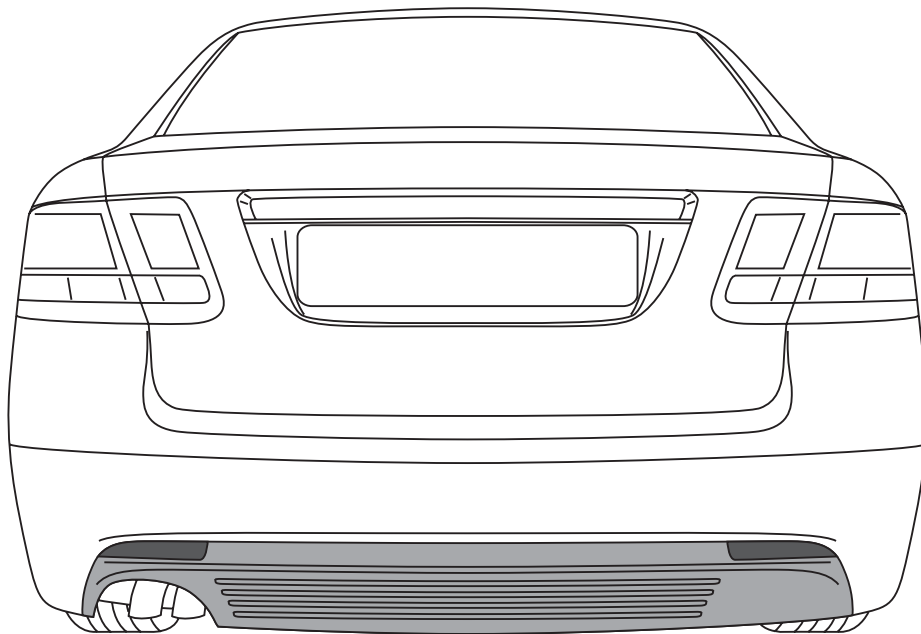

**MONTERINGSANVISNING • INSTALLATION INSTRUCTIONS
MONTAGEANLEITUNG • INSTRUCTIONS DE MONTAGE**

Accessories Part No.	Date	Instruction Part No.	Replaces
32 025 847	May 2007	32 026 187	

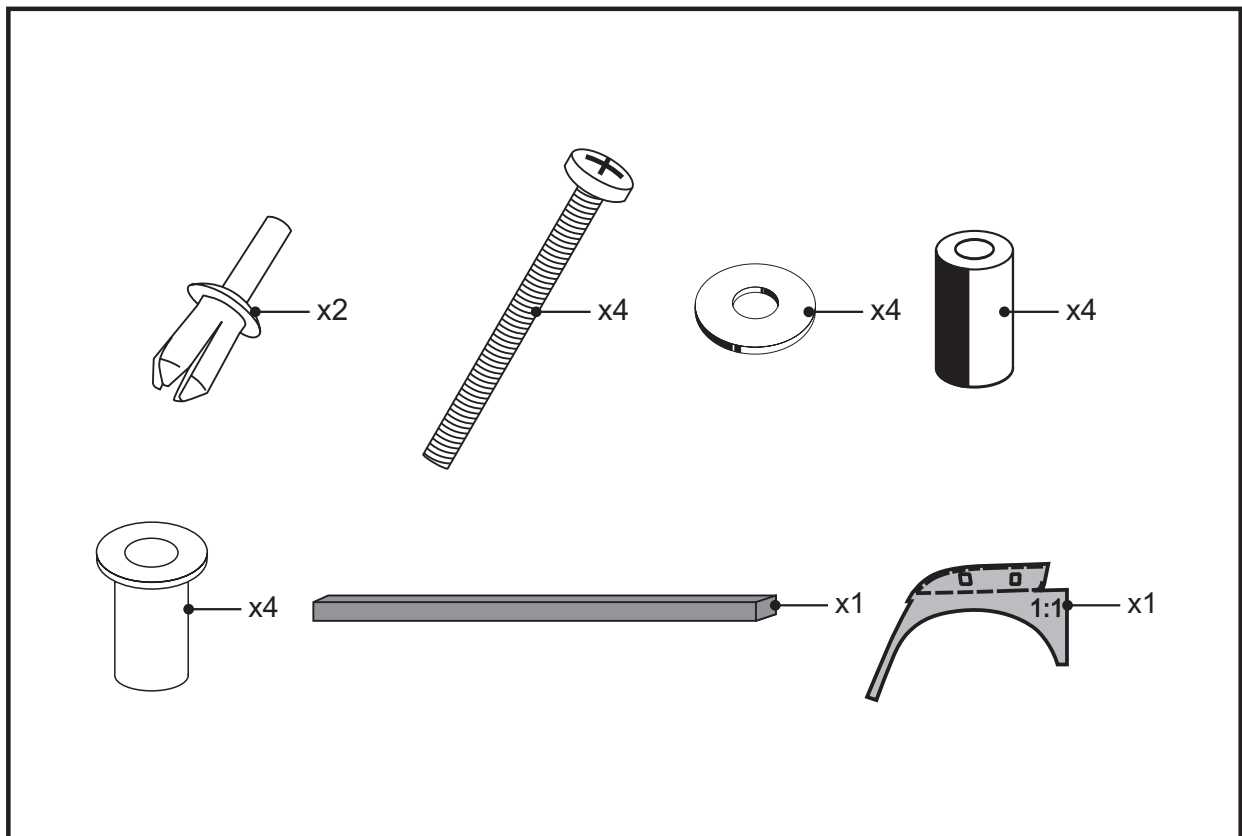

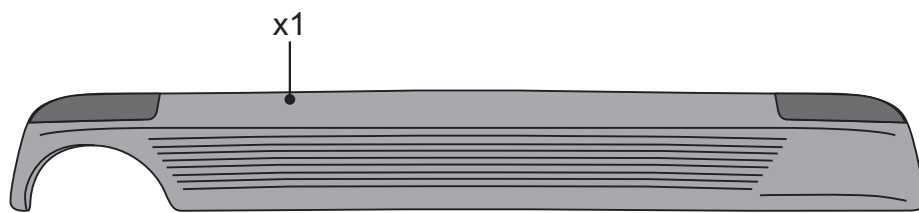

Important

WARNING

Read the Installation instructions carefully before using the accessory.

These installation instructions should be stored in the car.

In the event of uncertainty, contact your nearest dealer.

Do not drive the vehicle within 5 hours after the part installed!

Do not drive the vehicle with high speed (no more than 100km/h) within 24 hours after the part installed!

Do not use machine car wash within 48 hours after the part installed!

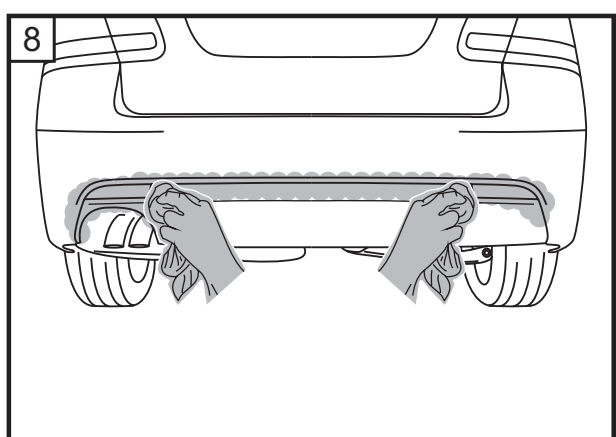
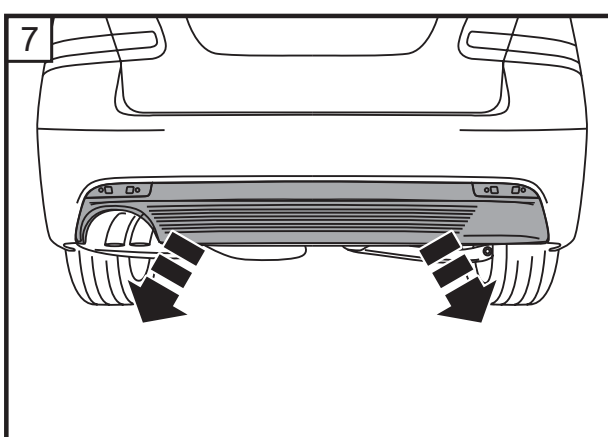
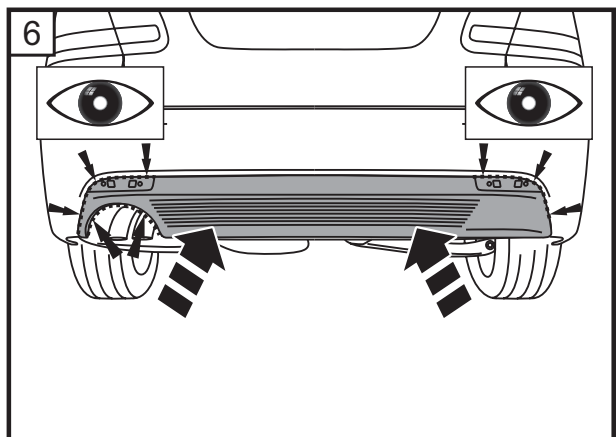
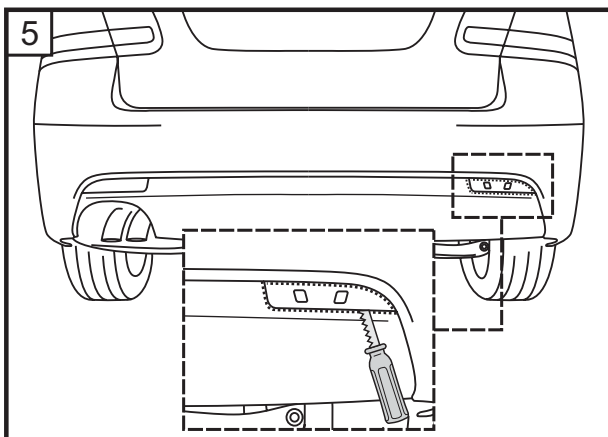
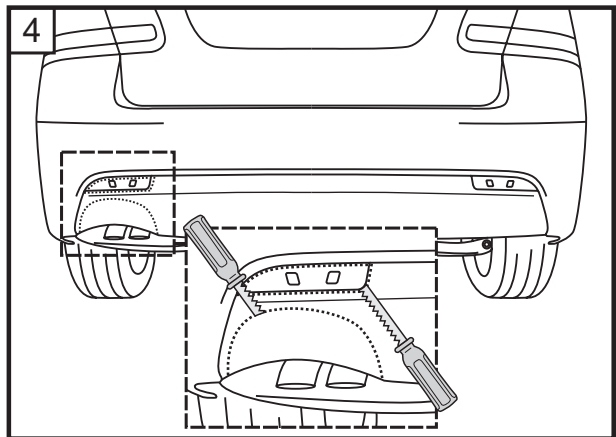
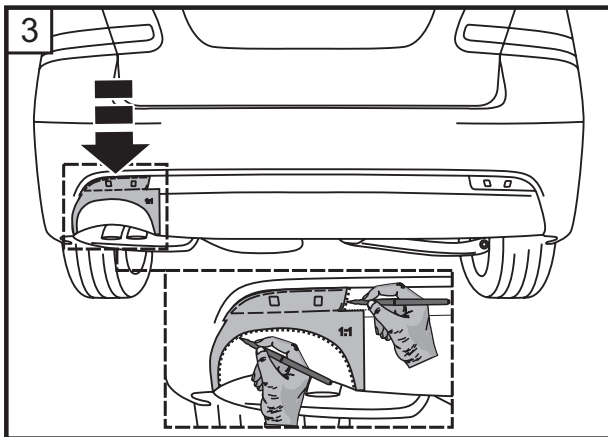
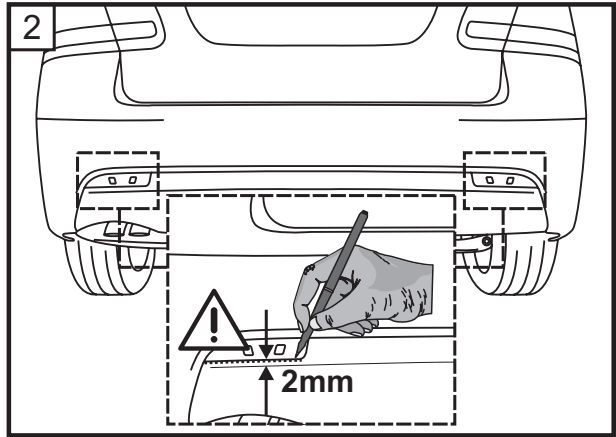
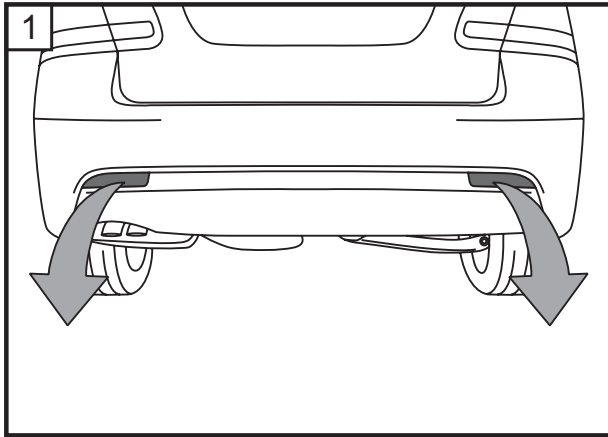

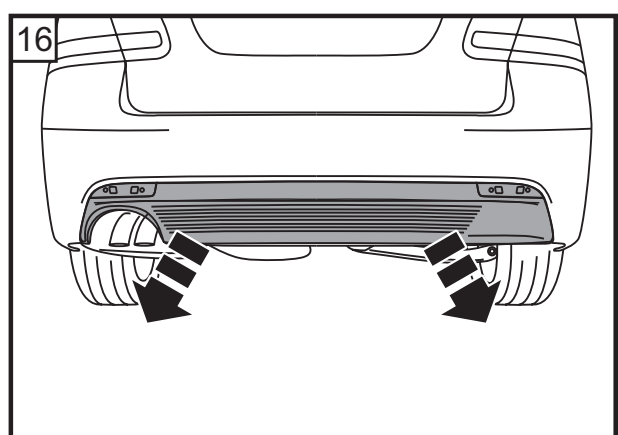
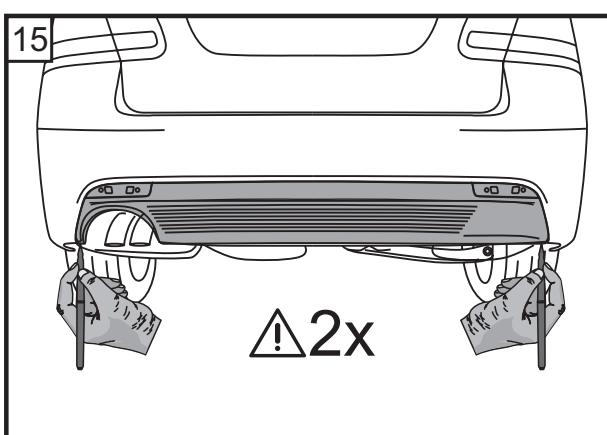
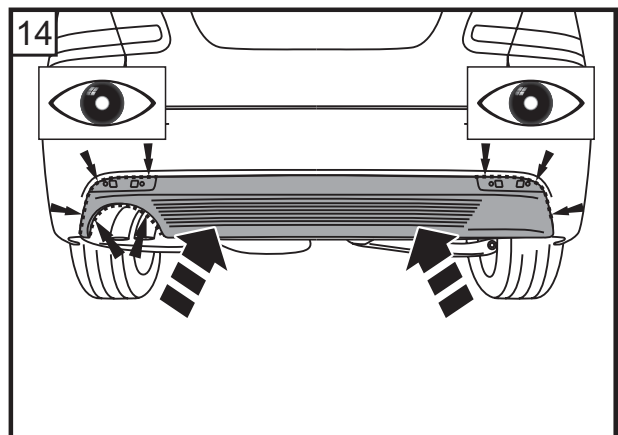
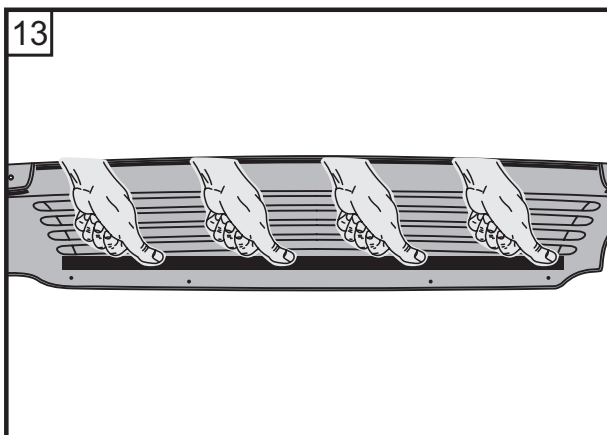
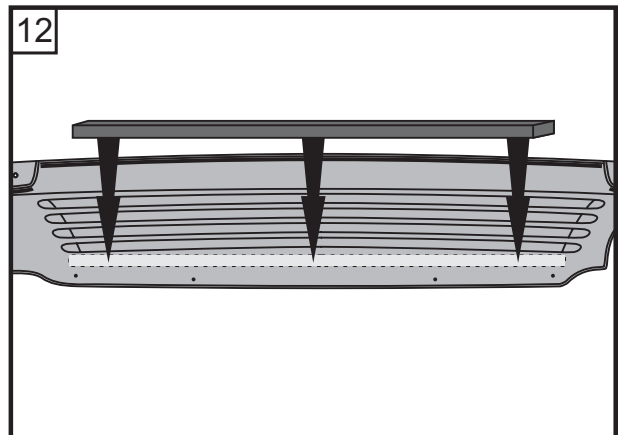
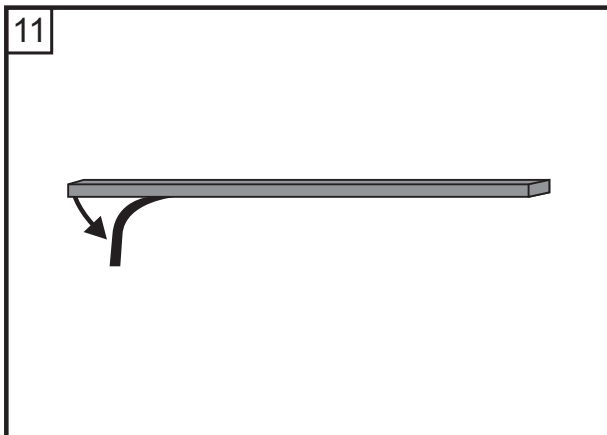
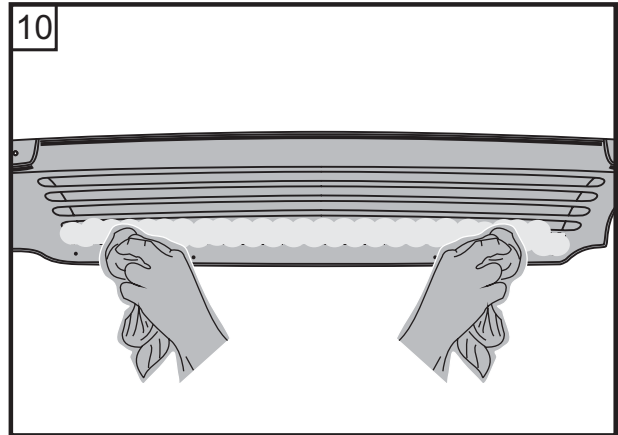
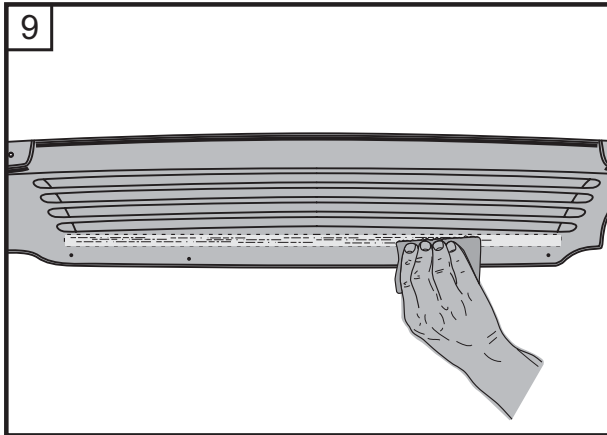

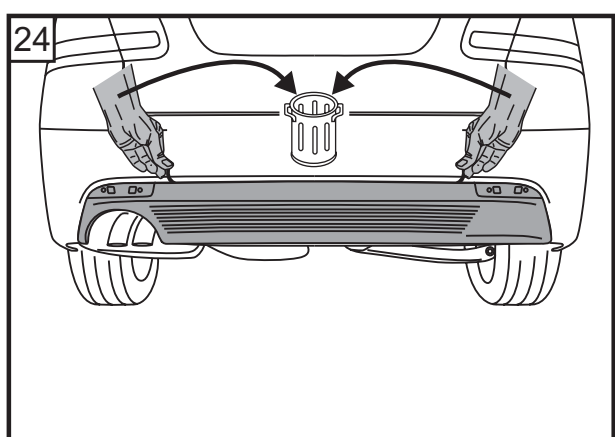
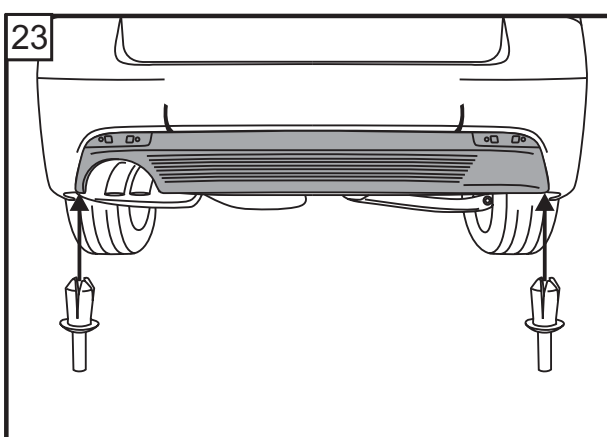
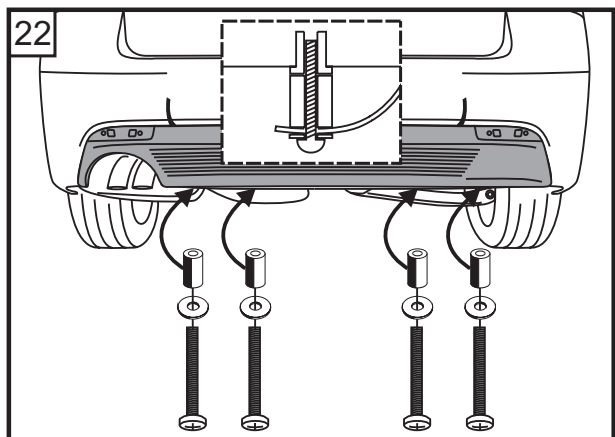
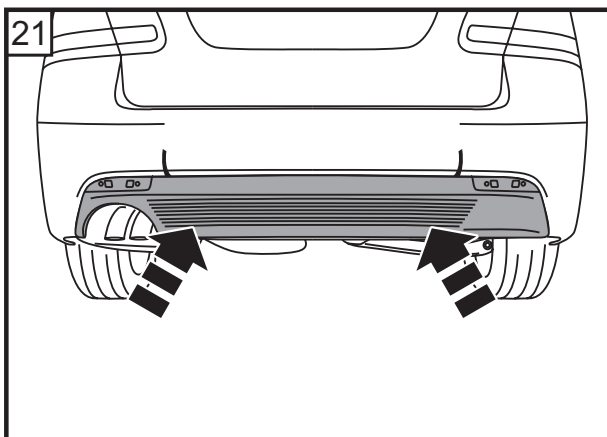
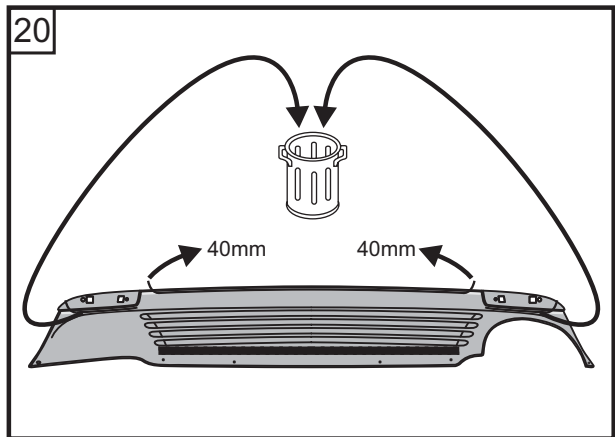
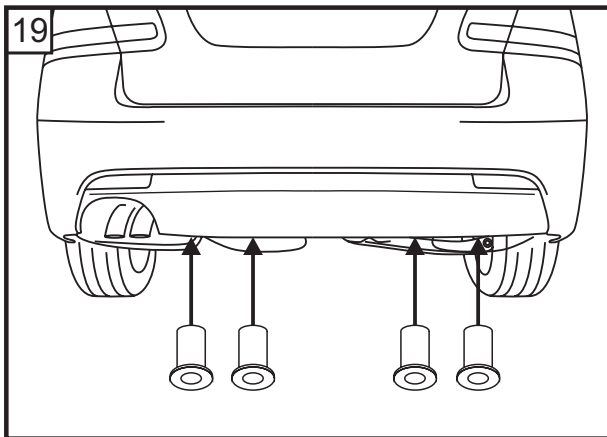
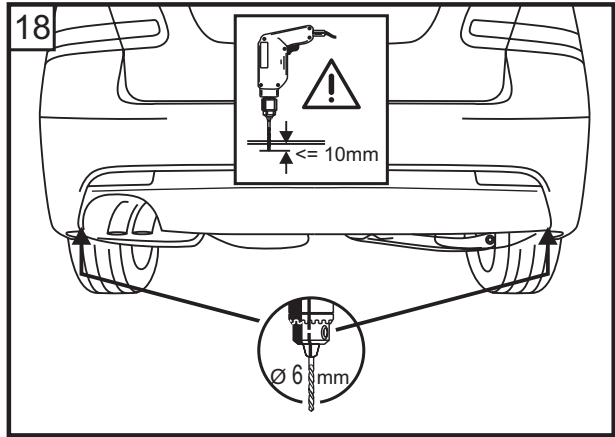
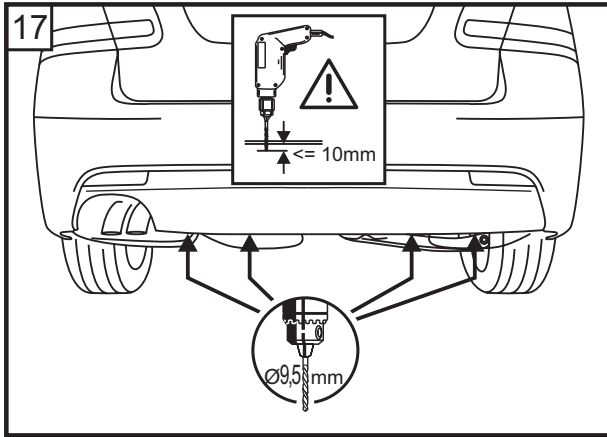

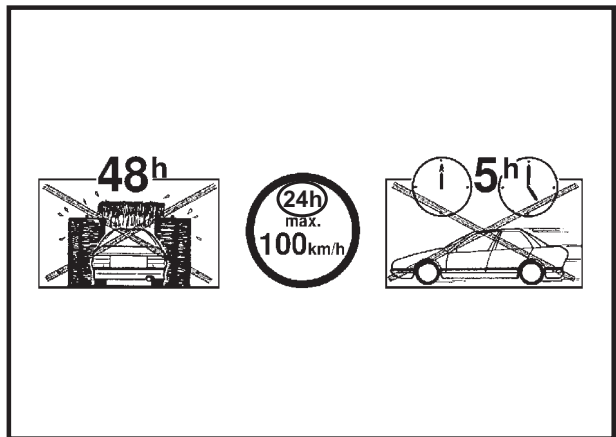
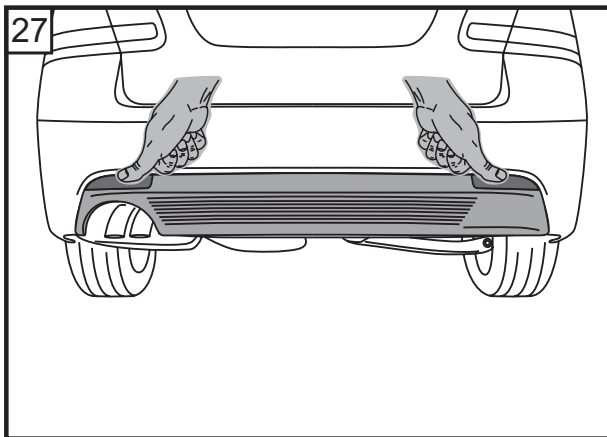
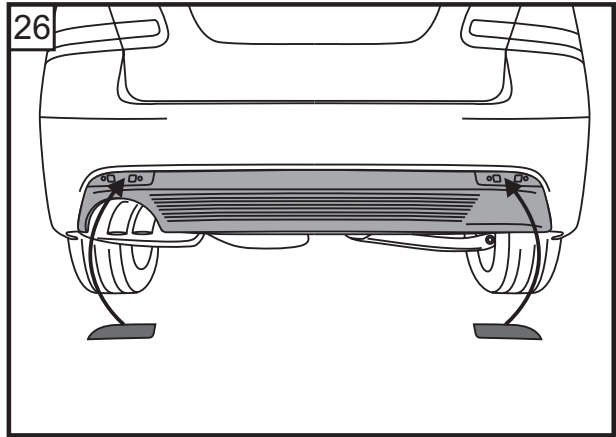
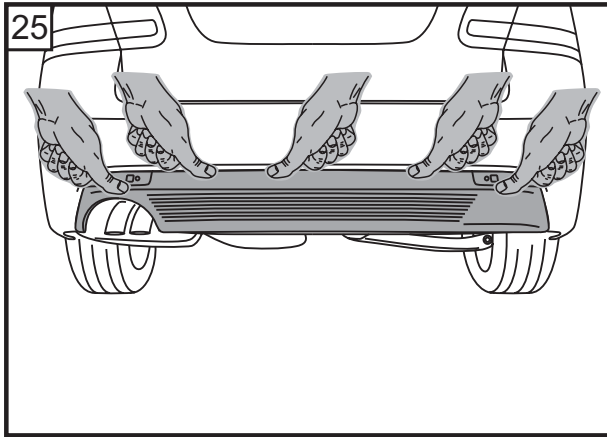





Painting instructions for primed parts

GB		Grind the primed component smoothly (P800-P1000). Avoid grinding through the primer.
		Check faulty spots, repair them and grind repaired places smoothly (P800-P1000). Re-prime ground-through spots using a suitable plastic primer.
		Thoroughly clean using a silicone remover.
		It is important to ensure adequate component support during the process of painting (distortion risk)! Paint buildup and application technique according to the paint manufacturer; the elasticity-imparting additives specified by the paint manufacturer are particularly important. The material designation is visible in the interior of the component (>.....<, z.B. >PUR-MF15<).
		No stoving of the paint (maximum 40°C)!