

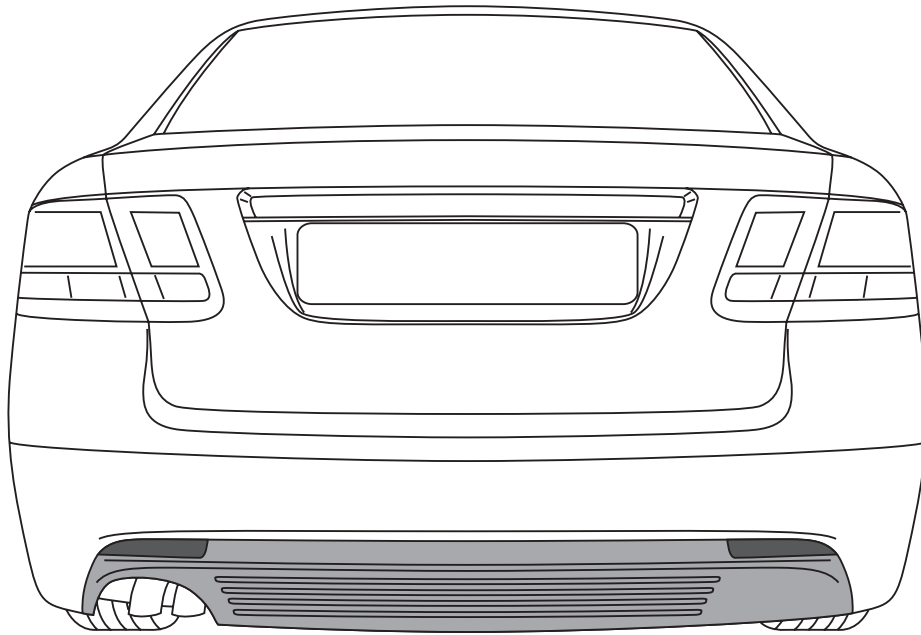

**MONTERINGSANVISNING • INSTALLATION INSTRUCTIONS
MONTAGEANLEITUNG • INSTRUCTIONS DE MONTAGE**

Accessories Part No.	Date	Instruction Part No.	Replaces
32 025 847	May 2007	32 026 187	

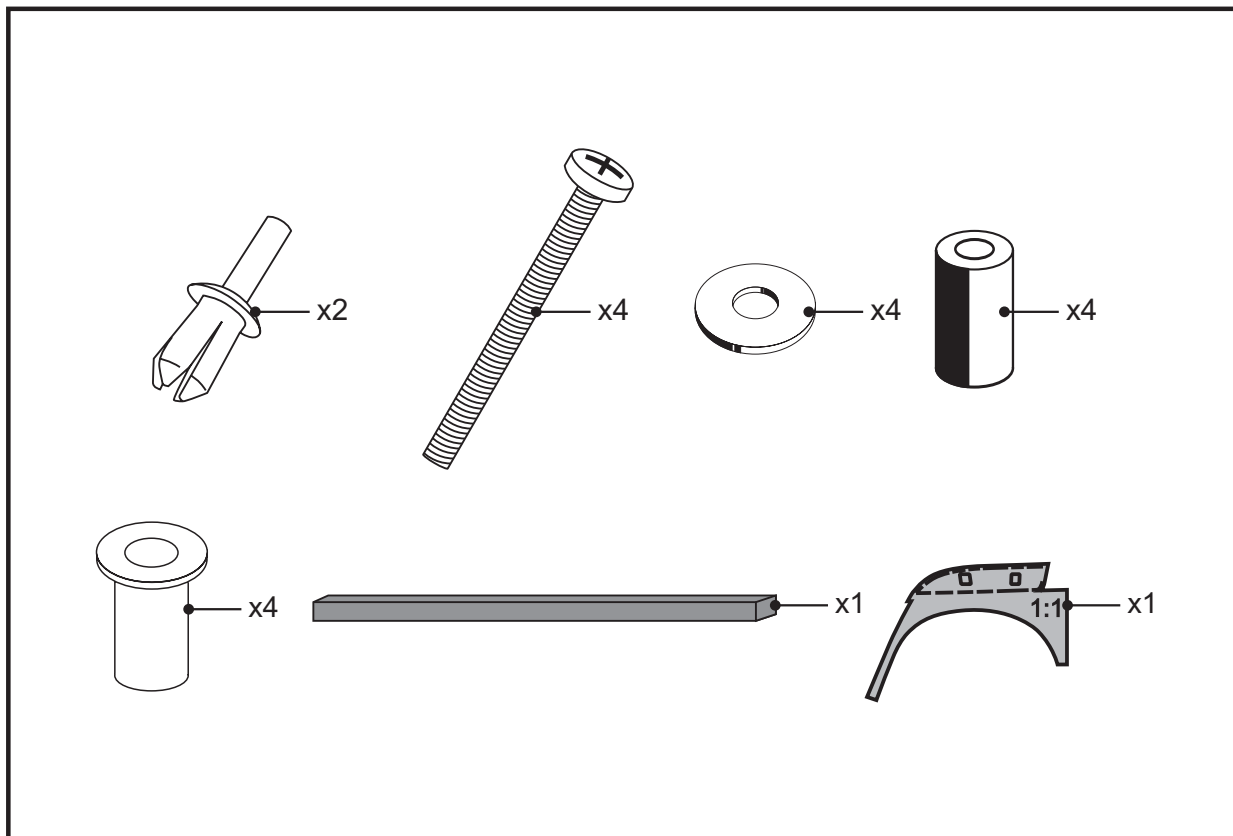

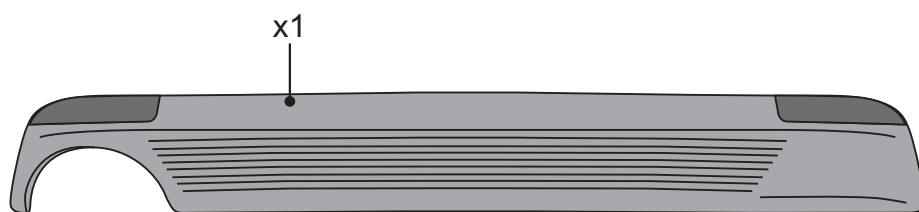

Tärkeää



Lue asennusohjeet huolellisesti ennen
lisävarusteosan käyttöä.

Asennusohjeet tulee säilyttää autossa.

Jos sinulla on kysymyksiä tai olet epävarma, ota
yhteyttä jälleenmyyjään.

Älä aja ajoneuvolla 5 tunnin sisällä osan
asentamisesta!

Älä aja ajoneuvolla suurilla nopeuksilla
(yli 100 km/h) 24 tunnin sisällä osan
asentamisesta!

Älä käytä koneellista autopesua 48 tunnin sisällä
osan asentamisesta!

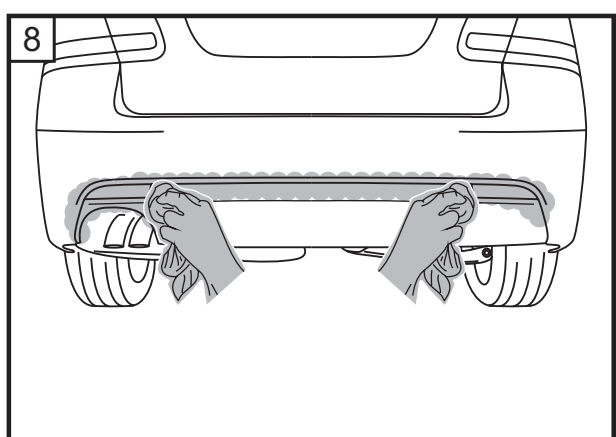
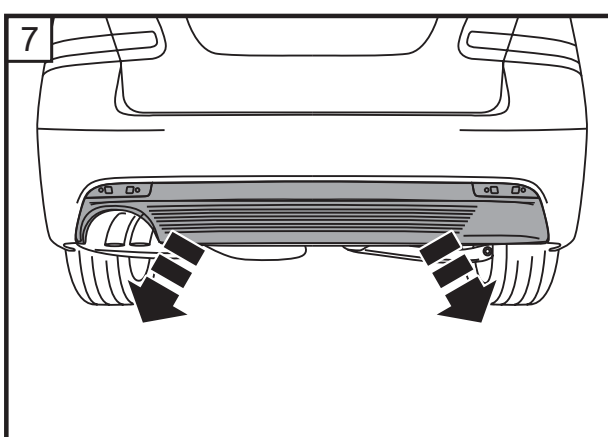
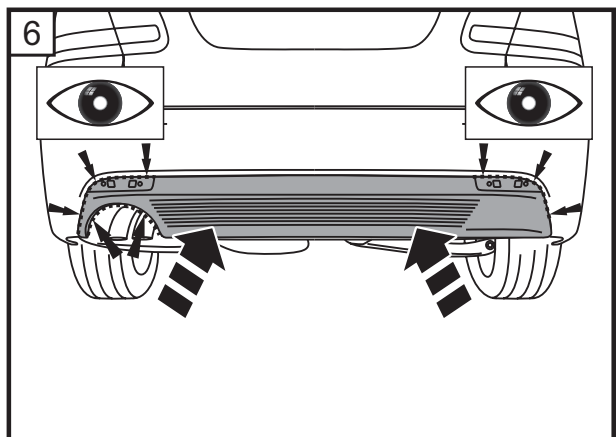
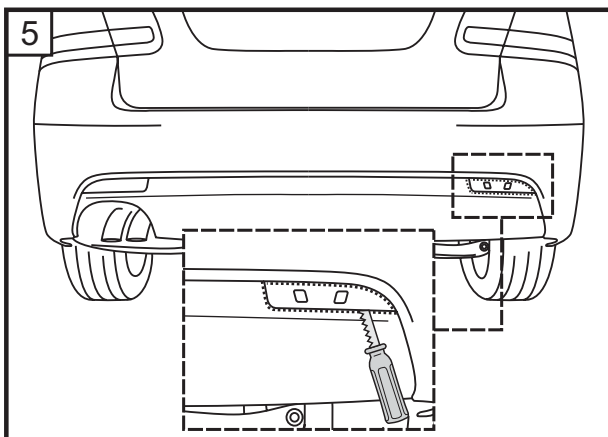
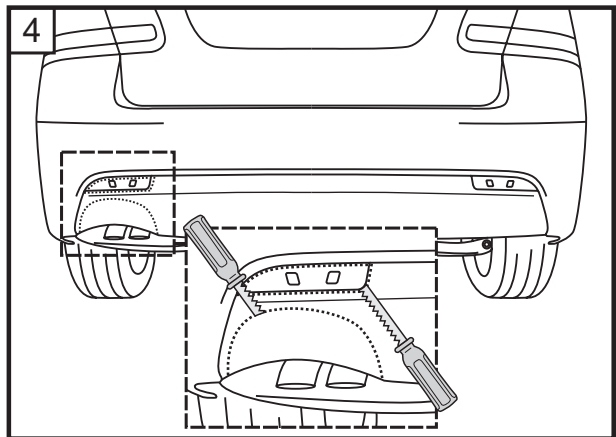
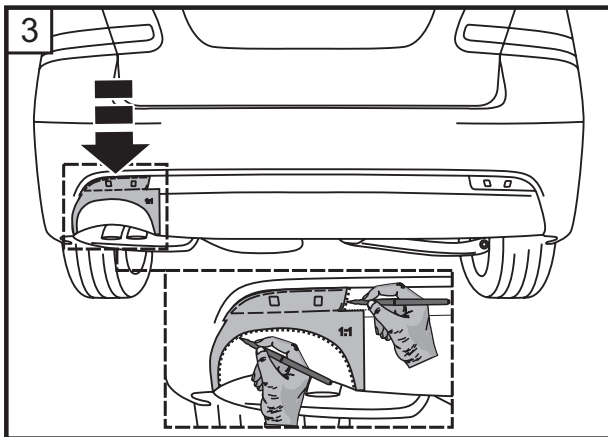
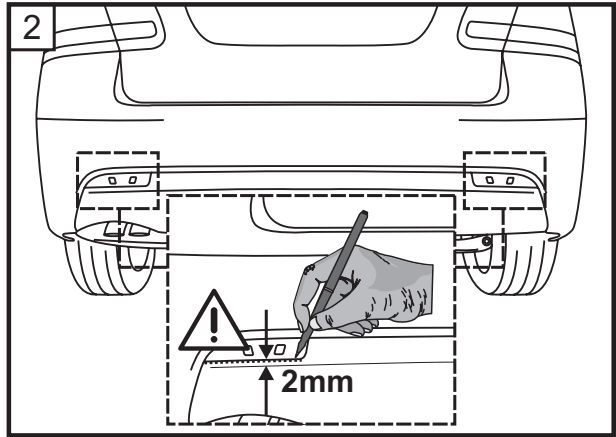
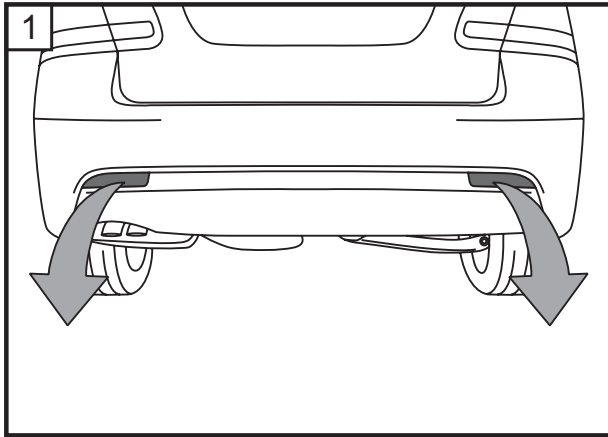

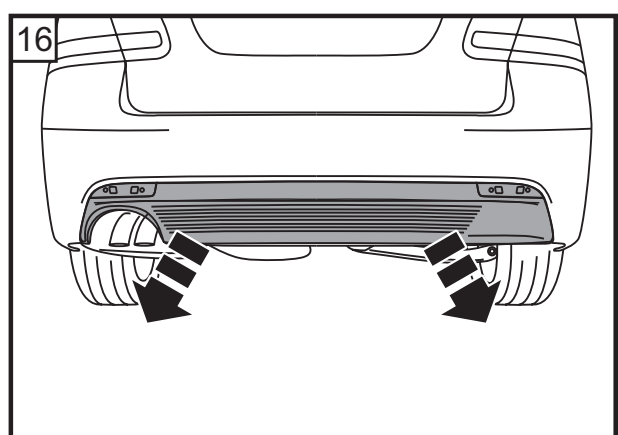
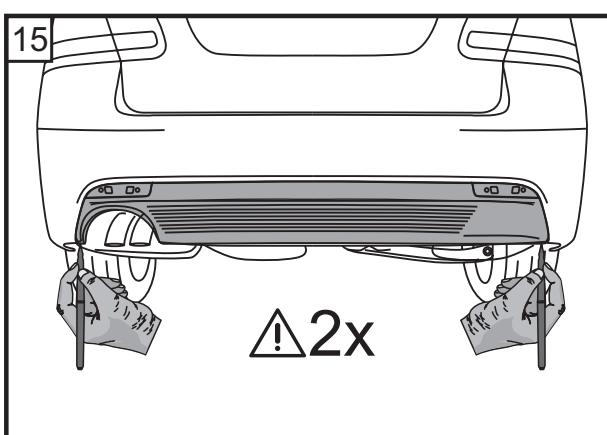
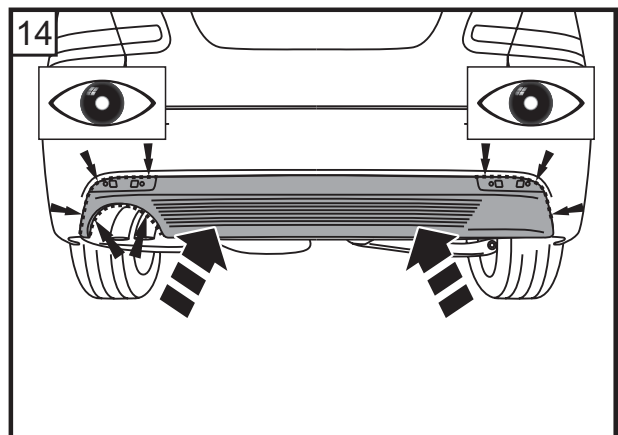
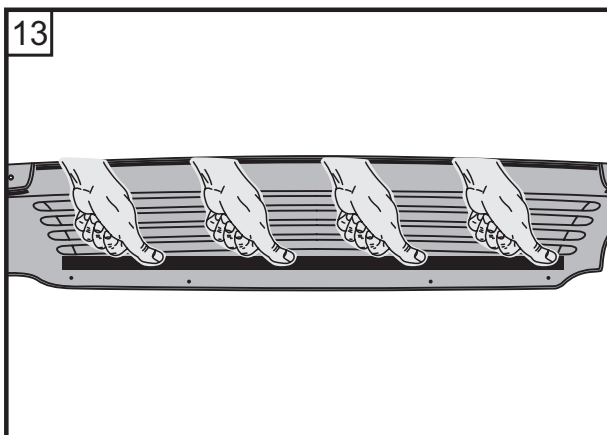
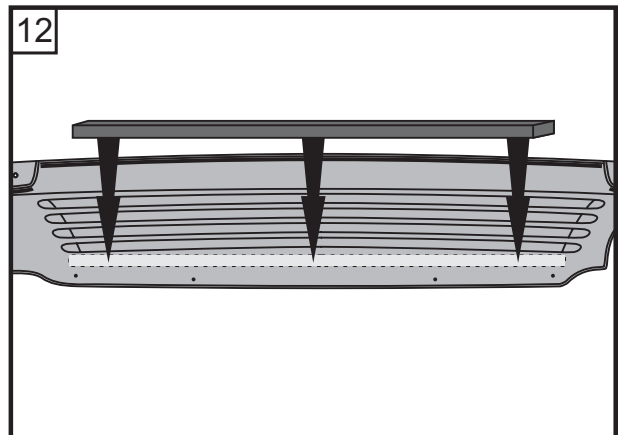
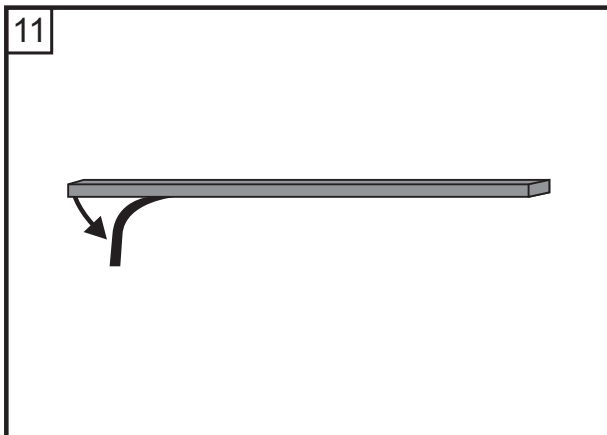
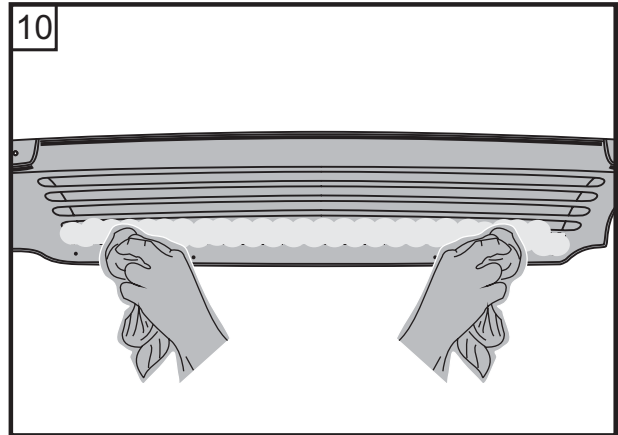
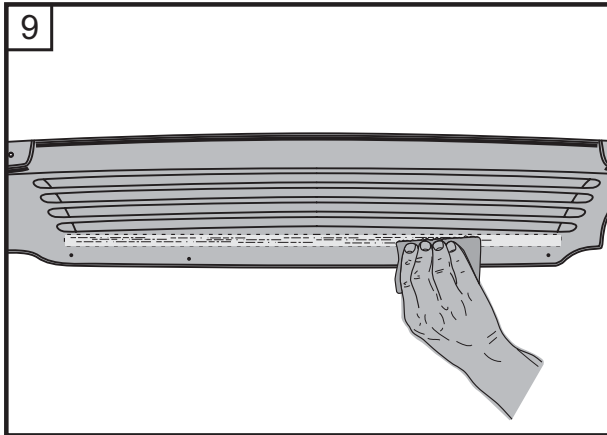

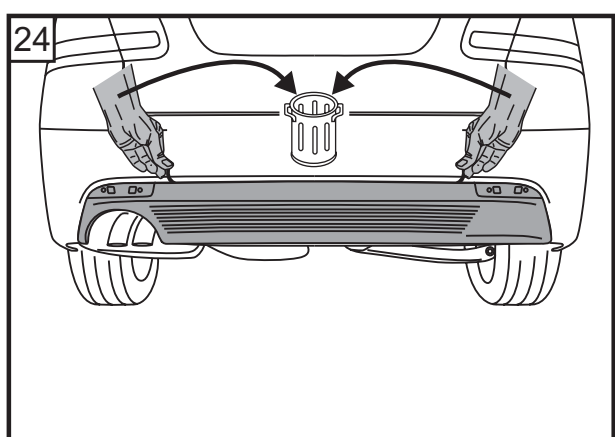
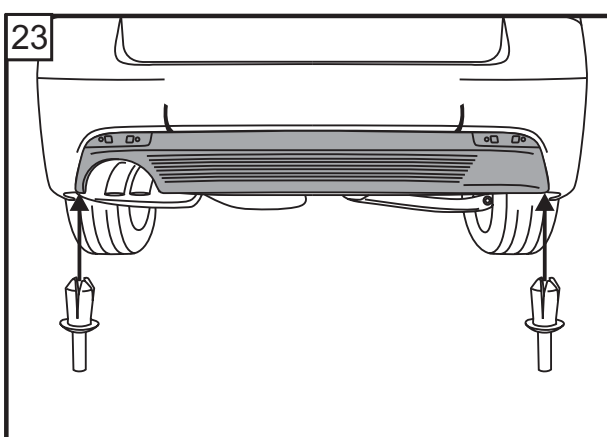
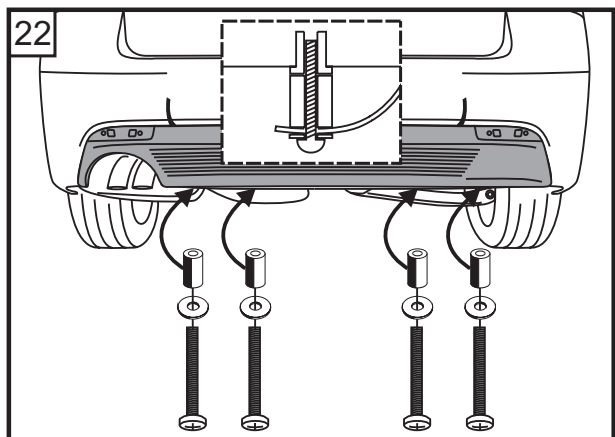
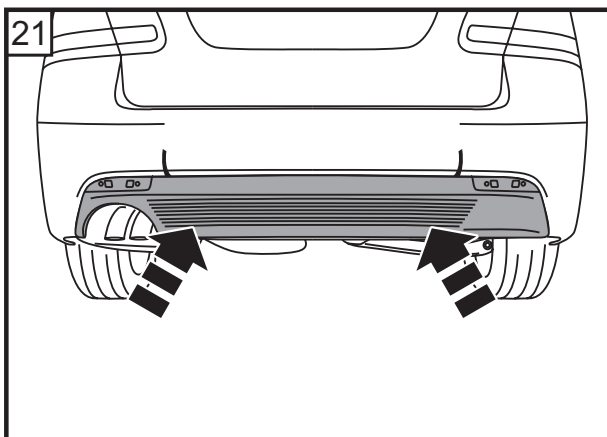
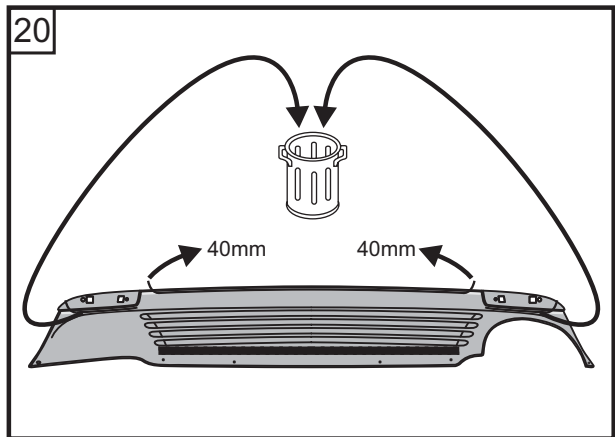
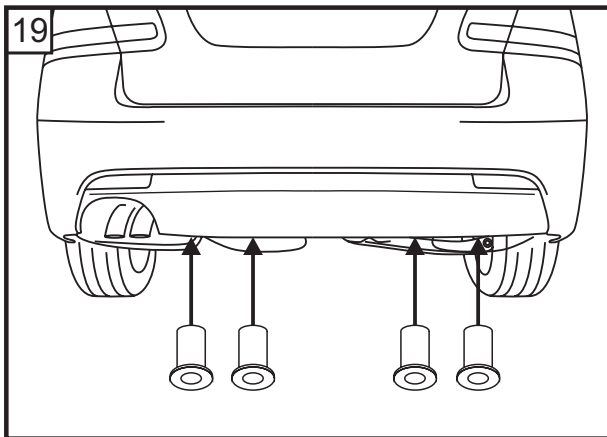
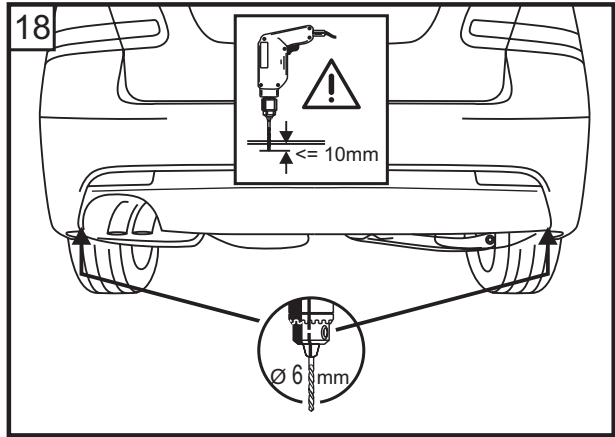
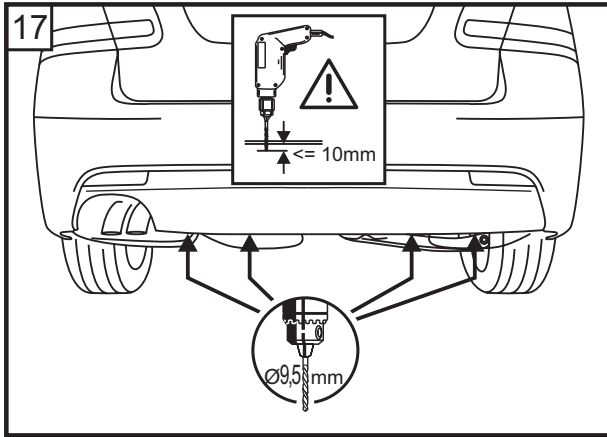

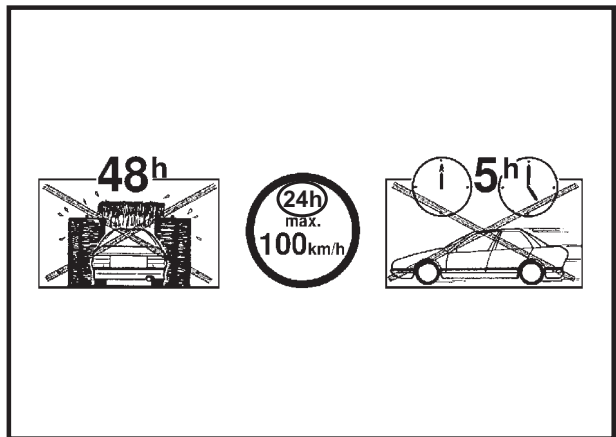
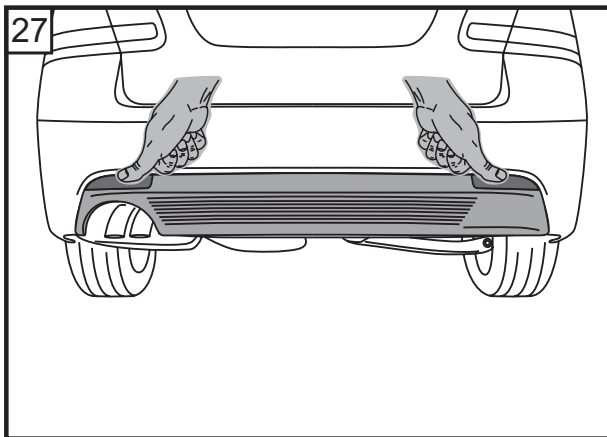
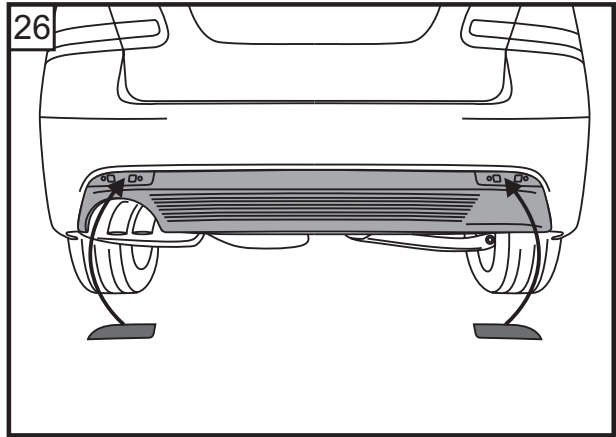
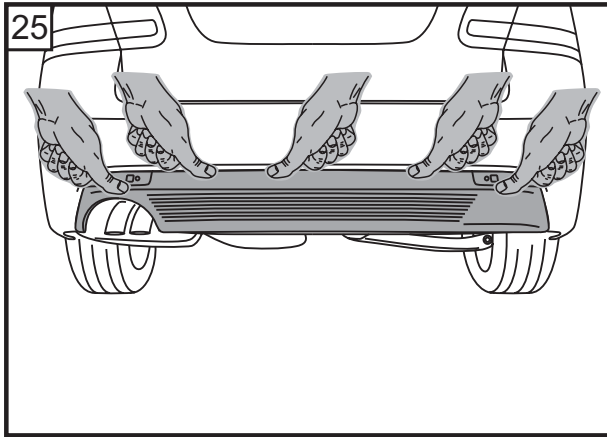





Pohjamaalattujen osien maalausohjeet

FI		Hio pohjamaalattu osa kevyesti (P800-P1000). Varo hiomasta pohjamaalia puhki.
		Tarkista osa virheellisten kohtien varalta, korjaa virheet ja hio korjatut kohdat kevyesti (P800-P1000). Pohjamaalaa läpihiotut kohdat uudelleen soveltuvalla muovipohjamaalilla.
		Puhdista huolellisesti silikoninpoistoaineella.
		Tue osa hyvin maalauksen aikana (vääntymisriski)! Maalin lisäys ja käyttötekniikat maalin valmistajan ohjeen mukaan, erityisesti valmistajan määrittämät elastisuutta lisäävät lisäaineet ovat tärkeitä. Materiaalimerkintä näkyy osan sisäosassa (>.....<, esim. >PUR-MF15<).
		Ei polttomaalausta (enint. 40 °C)!