

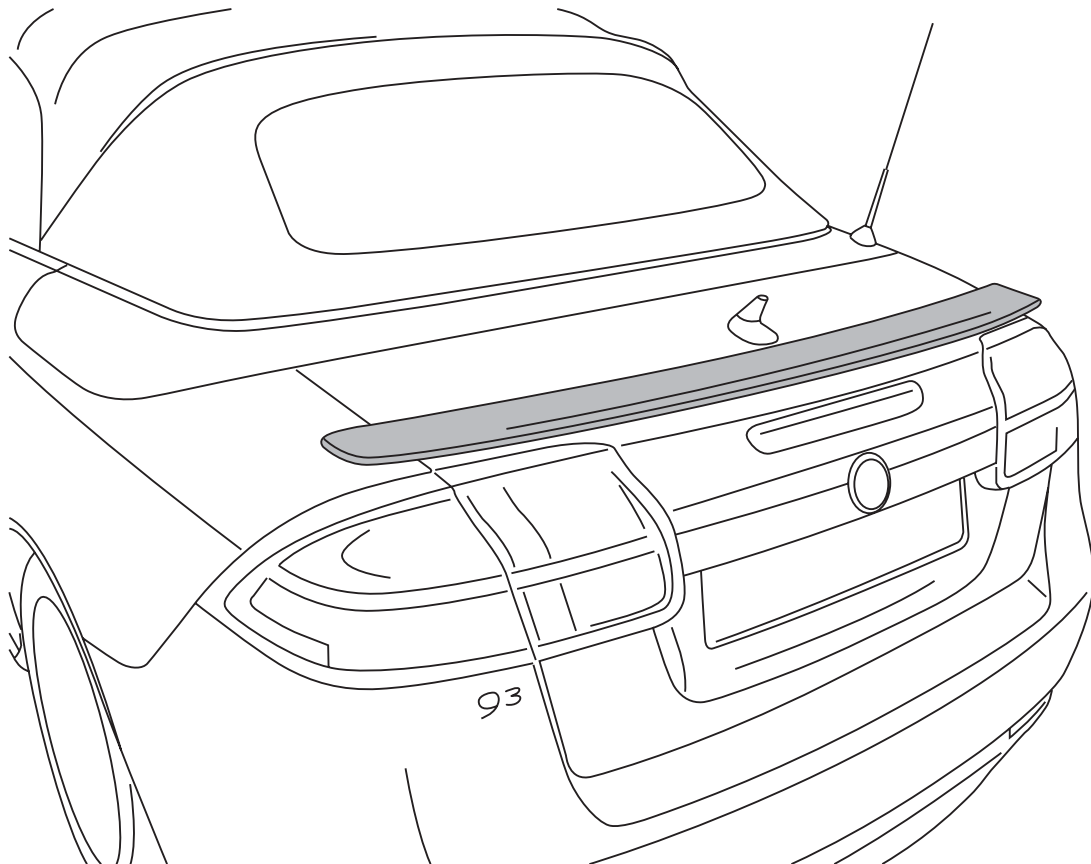

**MONTERINGSANVISNING • INSTALLATION INSTRUCTIONS
MONTAGEANLEITUNG • INSTRUCTIONS DE MONTAGE**

Accessories Part No.	Date	Instruction Part No.	Replaces
32 025 846	May 2007	32 026 185	

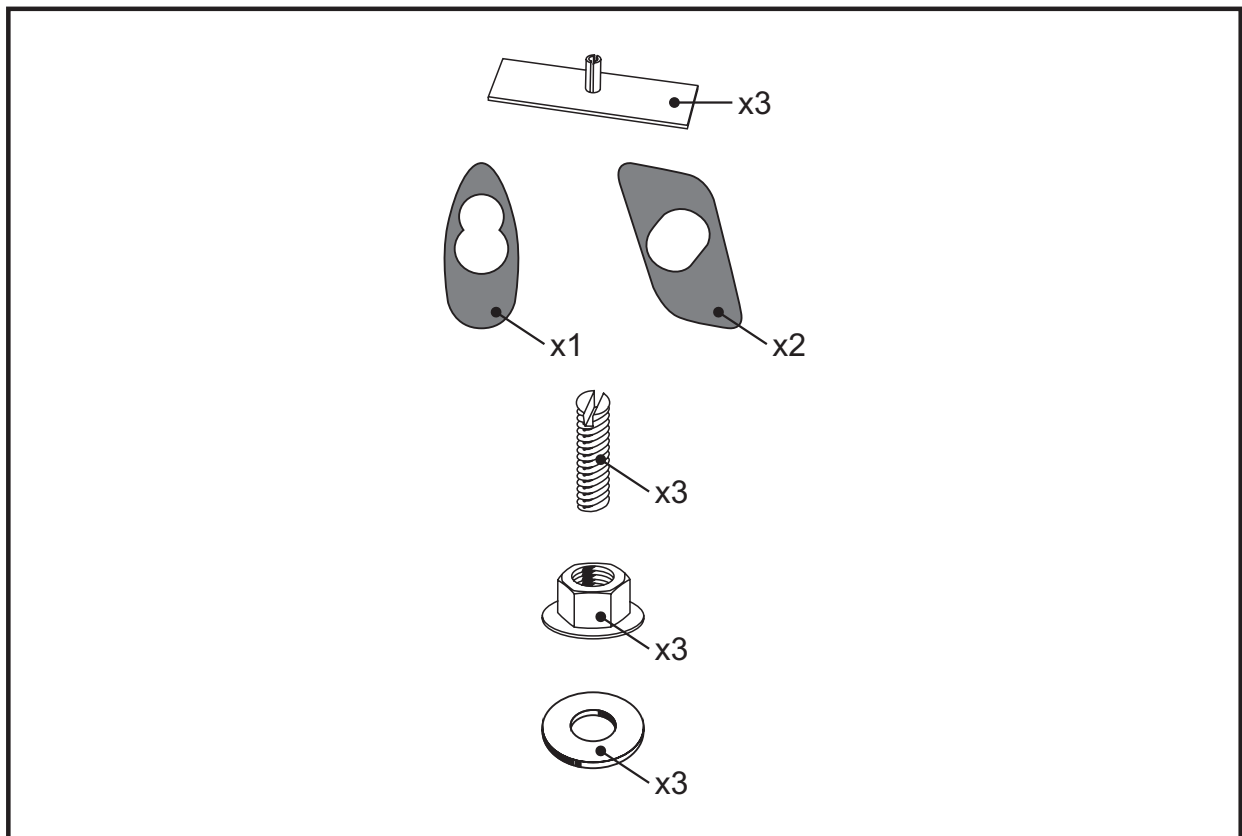

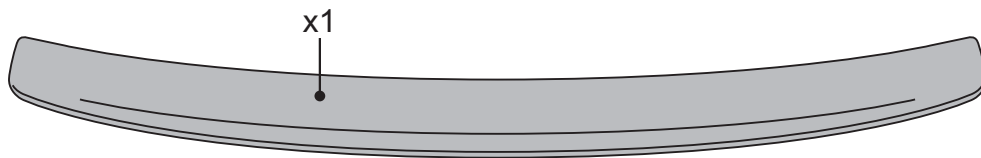

Important

AVERTISSEMENT

Lire attentivement les instructions d'installation avant d'utiliser l'accessoire.

Ces instructions d'installation devraient rester dans la voiture.

En cas de doute, contactez votre revendeur le plus proche.

Attendre 5 heures après l'installation de l'accessoire pour rouler !

Ne pas rouler à grande vitesse (au-dessus de 100 km/h) dans les 24 heures suivant l'installation de l'accessoire !

Ne pas passer au lavage automatique dans les 48 heures suivant l'installation de l'accessoire !

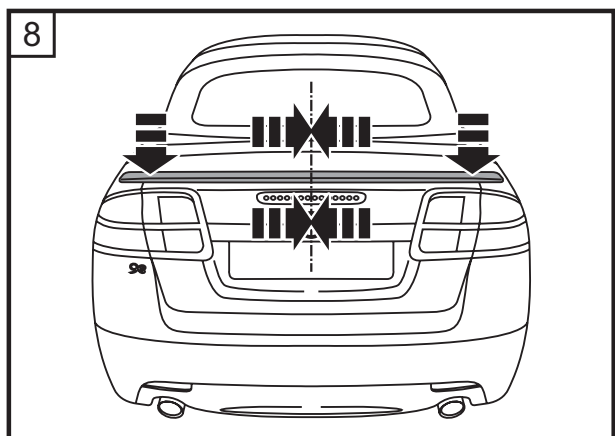
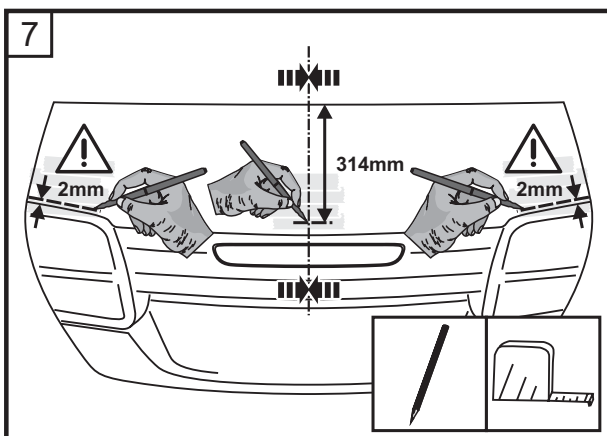
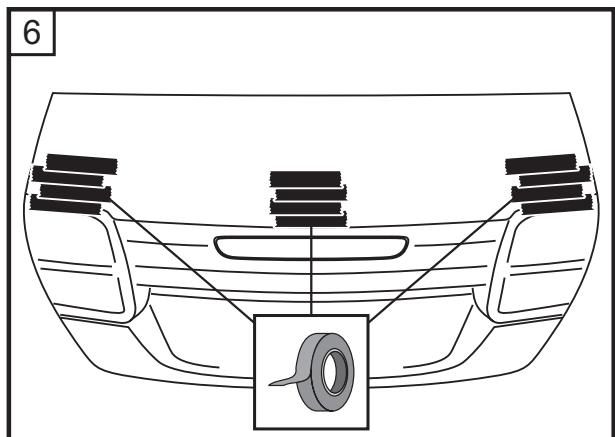
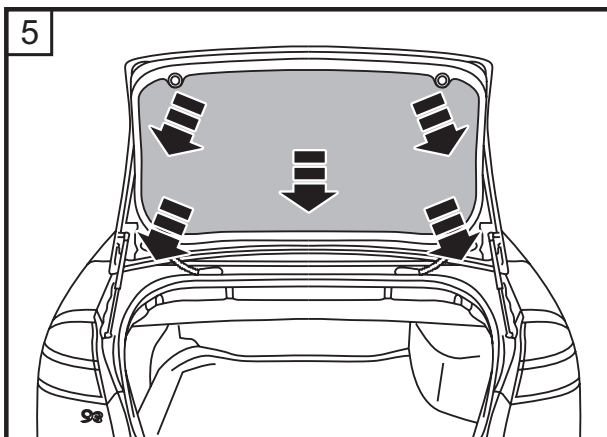
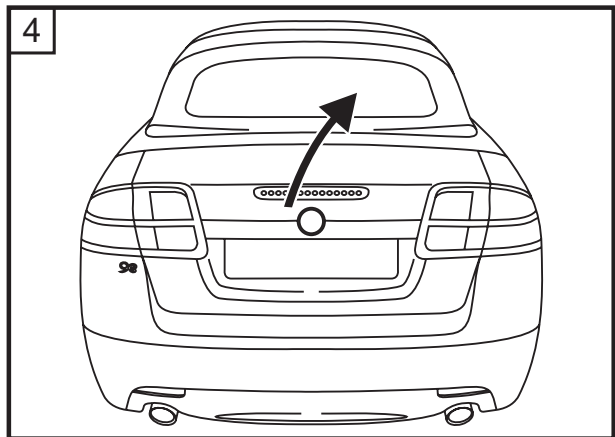
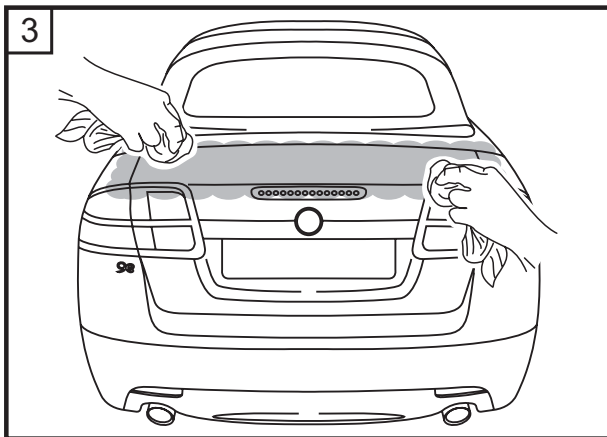
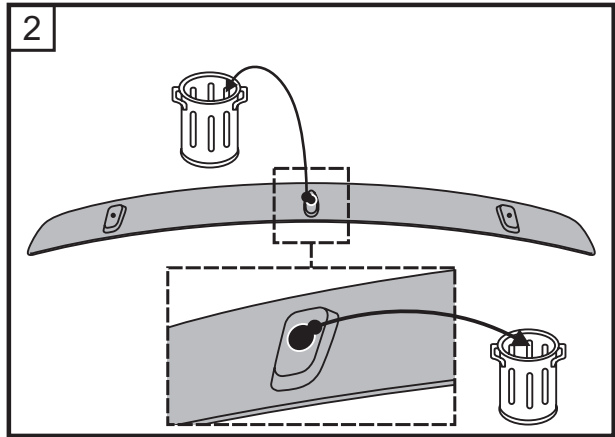
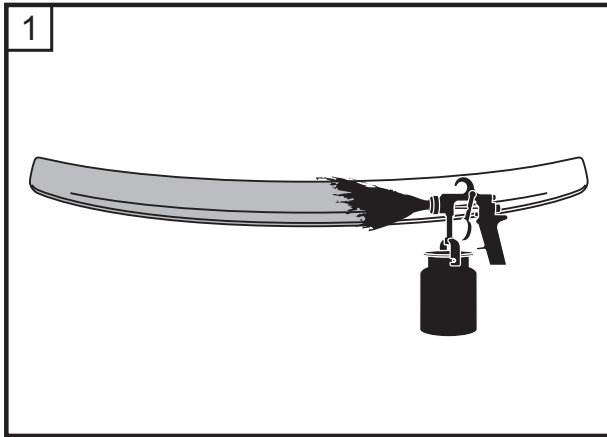

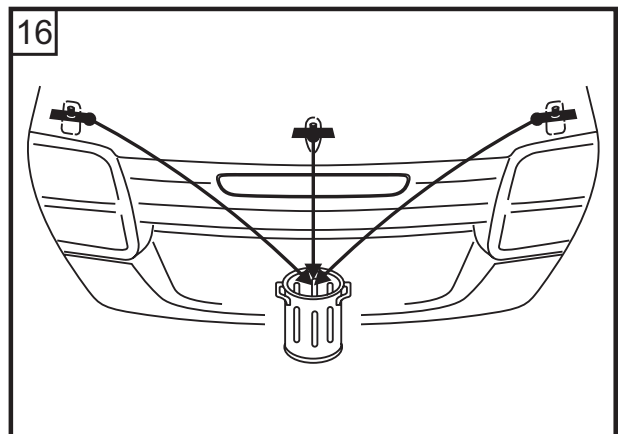
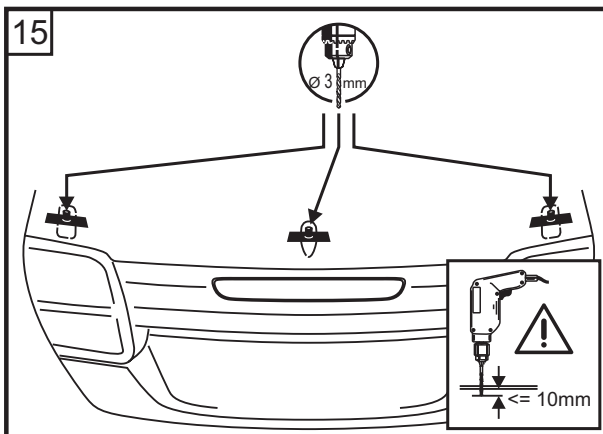
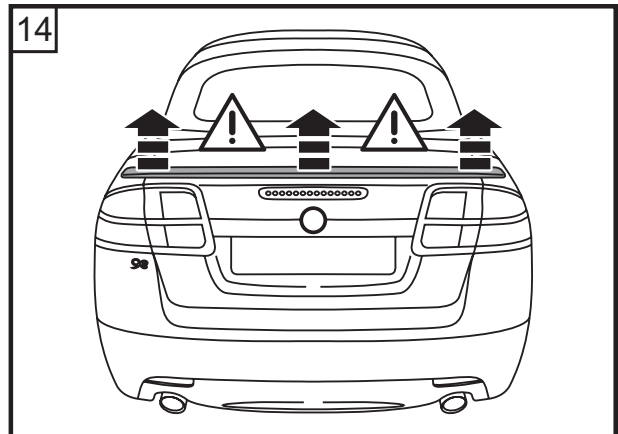
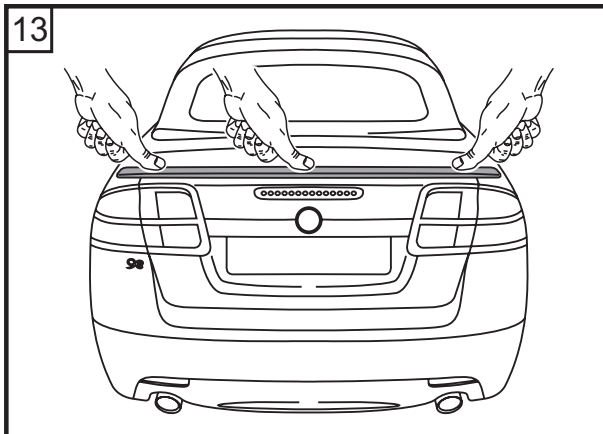
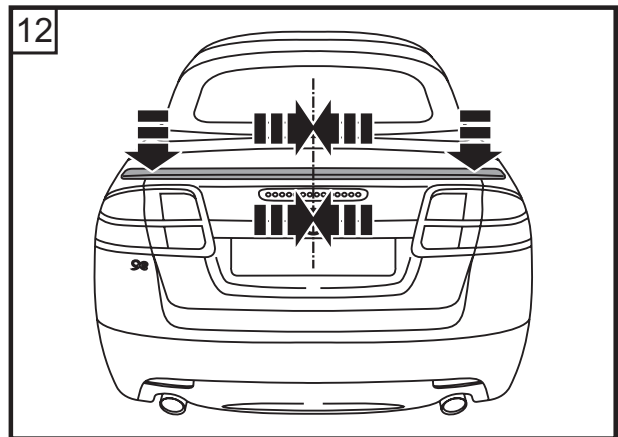
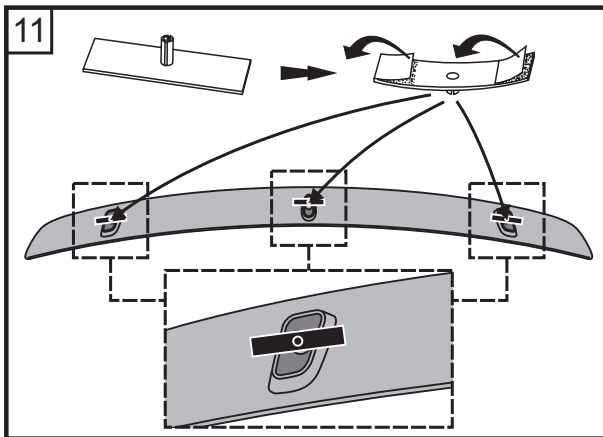
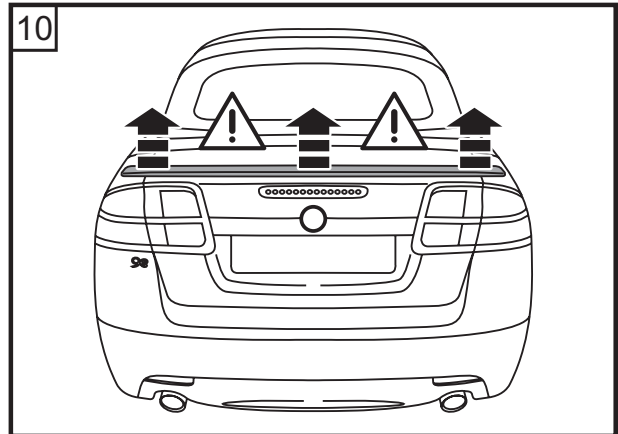
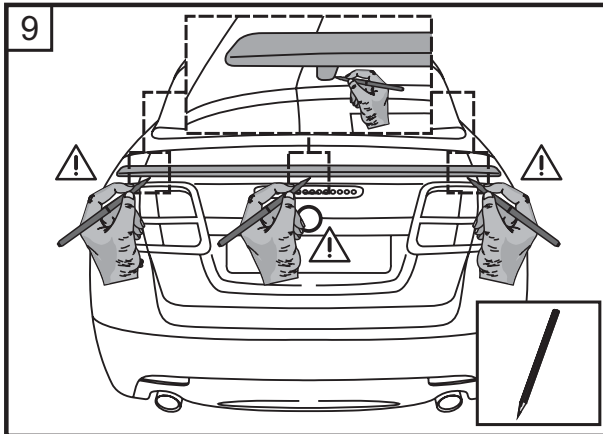

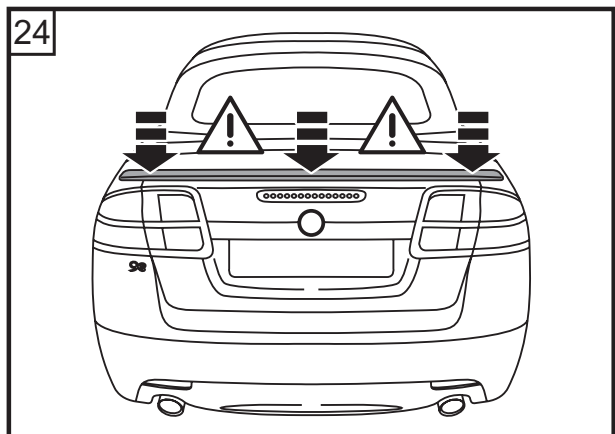
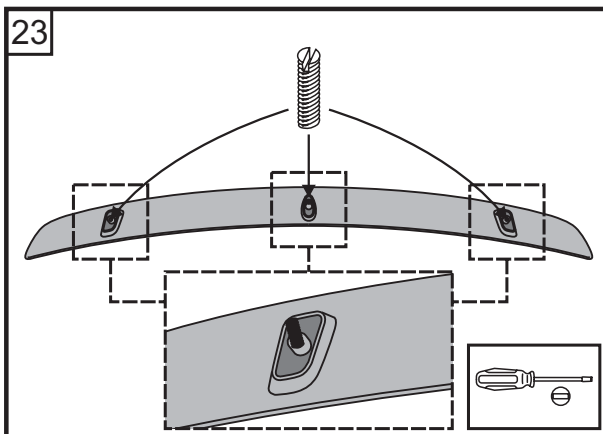
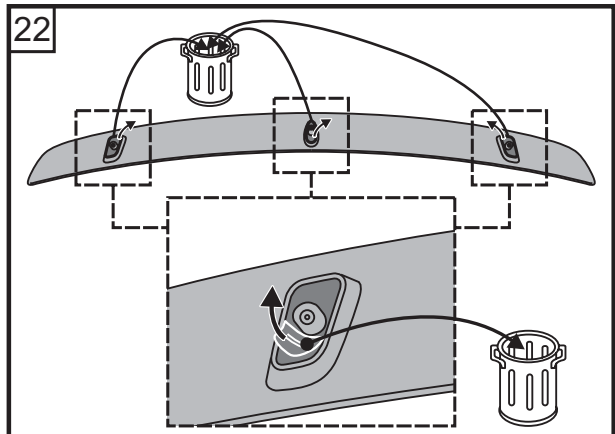
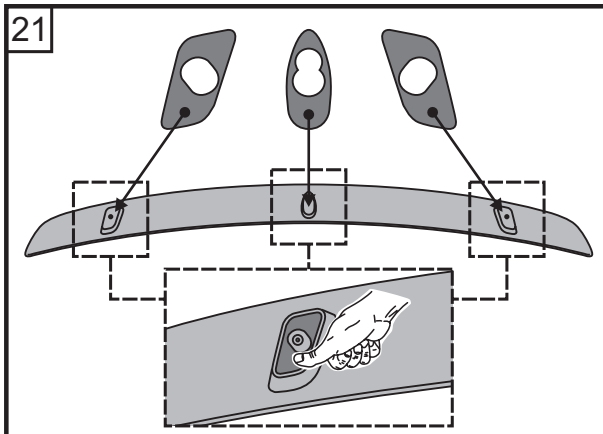
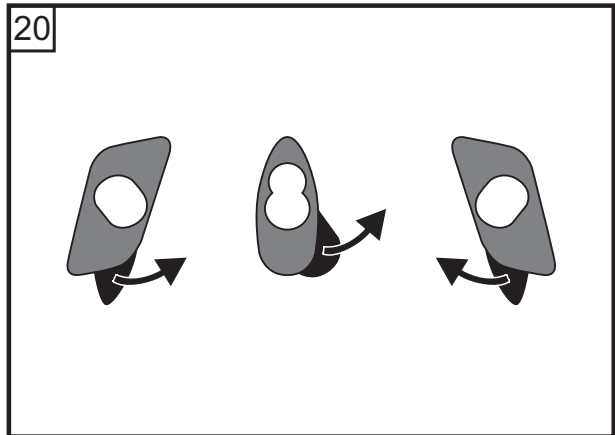
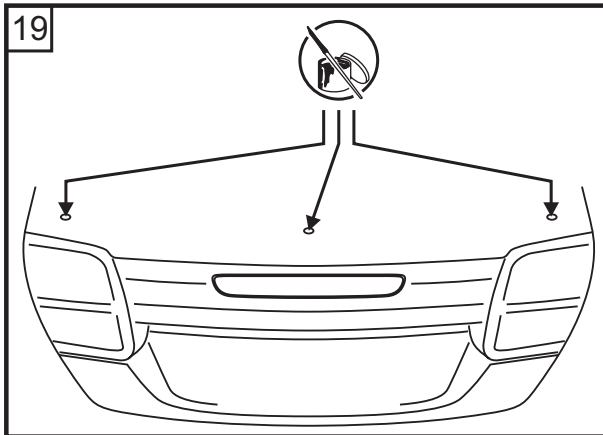
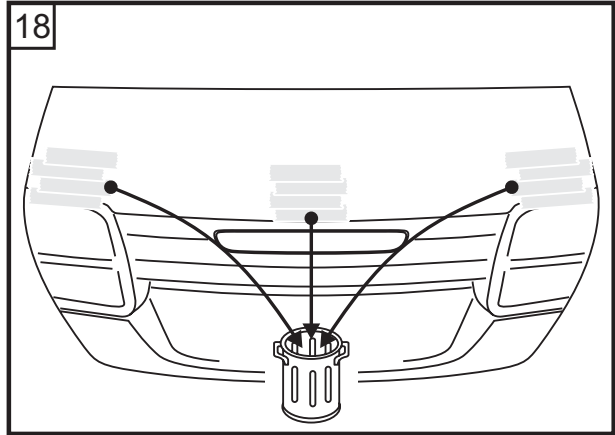
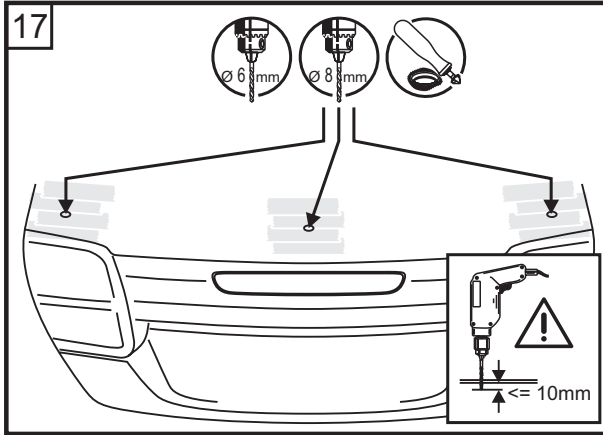

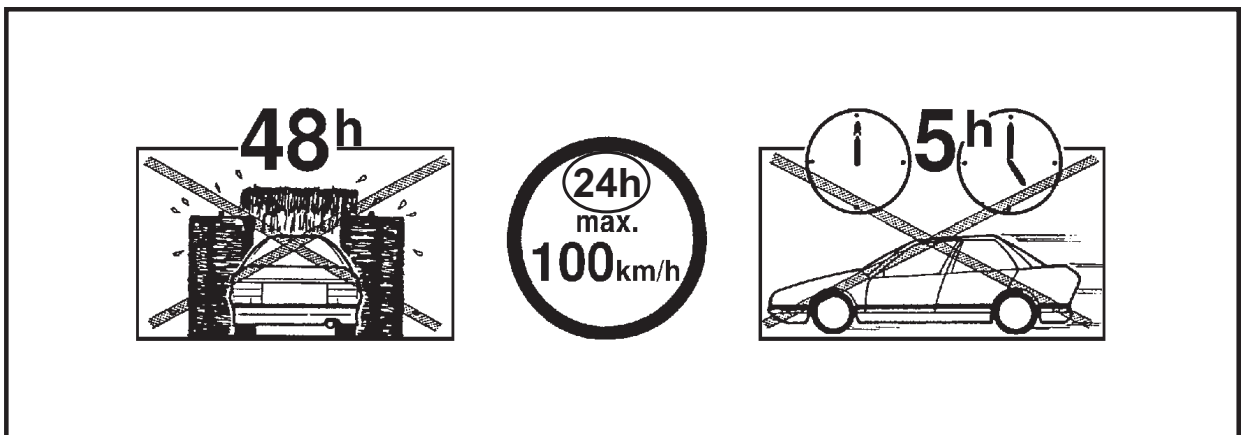
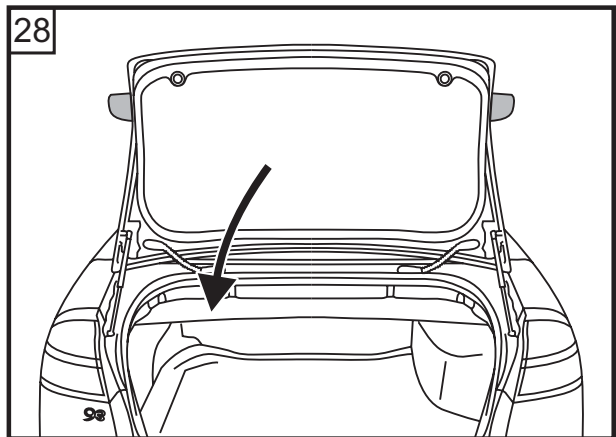
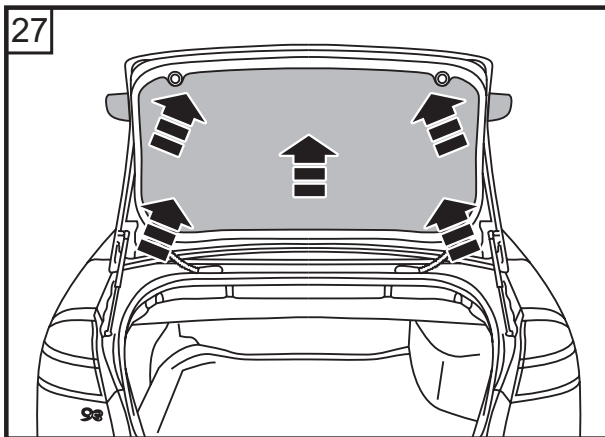
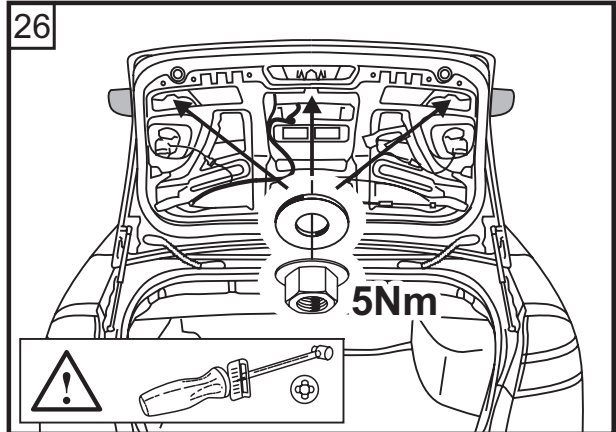
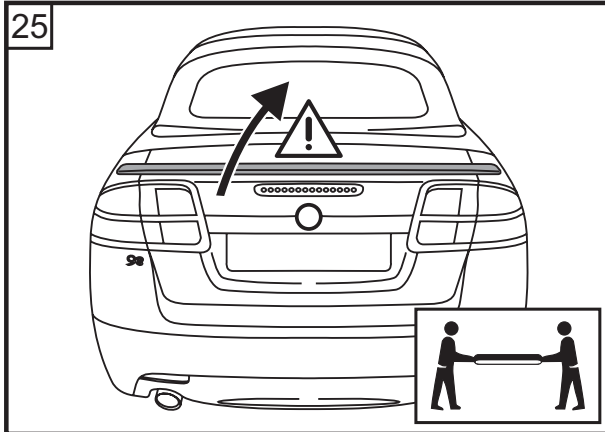





Instructions pour les parties à peindre

FR		Poncer l'élément apprêté doucement (P800-P1000). Eviter de poncer au travers de la couche primaire.
		Repérer et réparer les défauts, puis poncer les parties réparées doucement (P800-P1000). Appliquer un primaire d'accrochage adapté sur les parties creuses.
		Nettoyer entièrement avec un décapant silicone.
		Il faut s'assurer du bon accrochage du produit durant l'application de la peinture (risque de déformation) ! Suivre les consignes du fabricant de peinture en matière de dosage et de technique d'application ; les additifs élastiques spécifiés par le fabricant de peinture ont une grande importance. La désignation des composants figure à l'intérieur de l'élément (>.....<, par exemple >PUR-MF15<).
		Ne pas chauffer la peinture (maximum 40°C) !
