

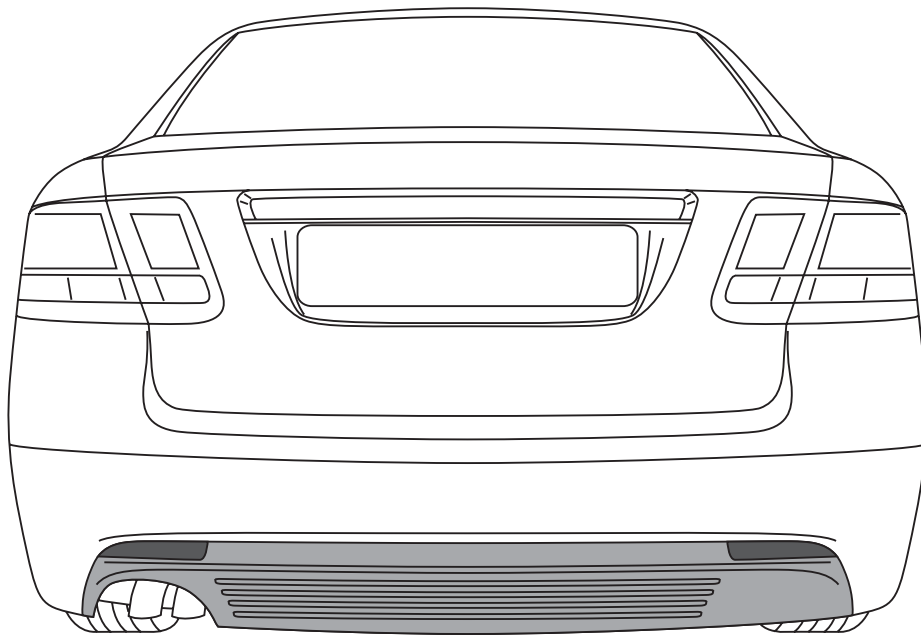

**MONTERINGSANVISNING • INSTALLATION INSTRUCTIONS
MONTAGEANLEITUNG • INSTRUCTIONS DE MONTAGE**

Accessories Part No.	Date	Instruction Part No.	Replaces
32 025 847	May 2007	32 026 187	

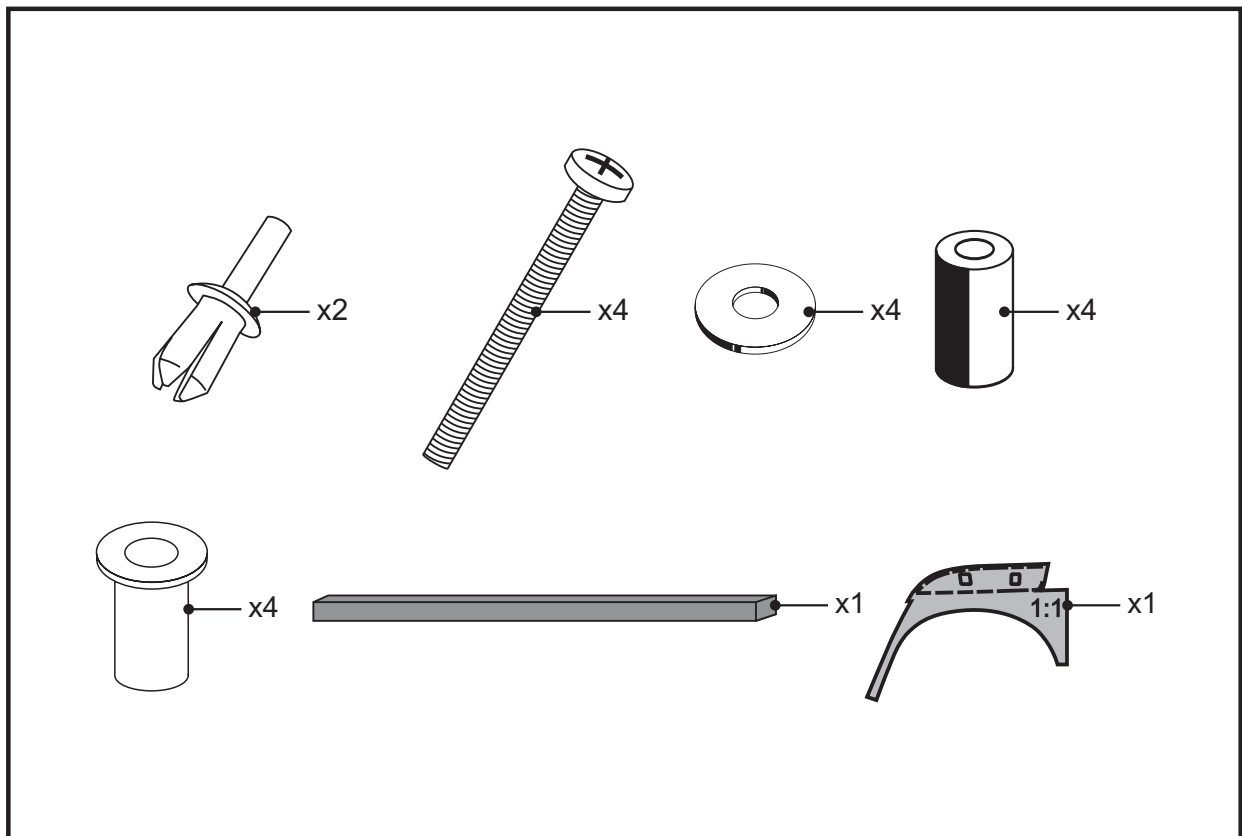

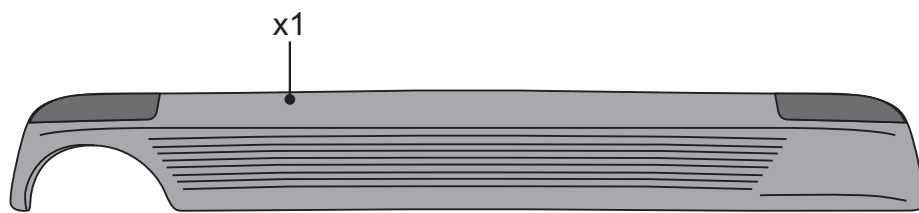

Viktigt **VARNING**

Läs installationsinstruktionerna noga innan du använder tillbehöret.

Installationsinstruktionerna bör förvaras i bilen.

Vid oklarheter, kontakta närmaste återförsäljare.

Kör inte med fordonet inom de närmaste 5 timmarna efter installationen!

Kör inte med fordonet med hög hastighet (mer än 100 km/h) inom de närmaste 24 timmarna efter installationen!

Maskintvätta inte fordonet inom de närmaste 48 timmarna efter installationen!

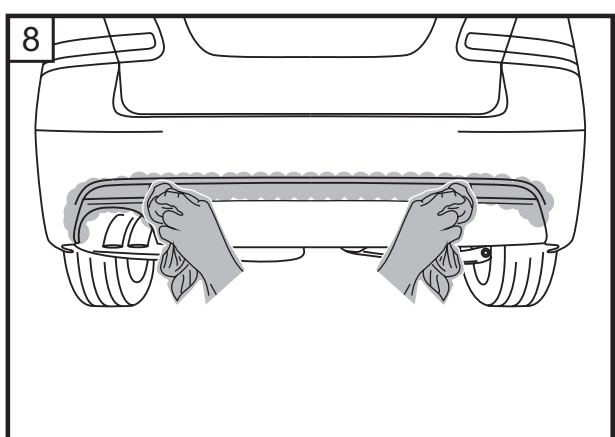
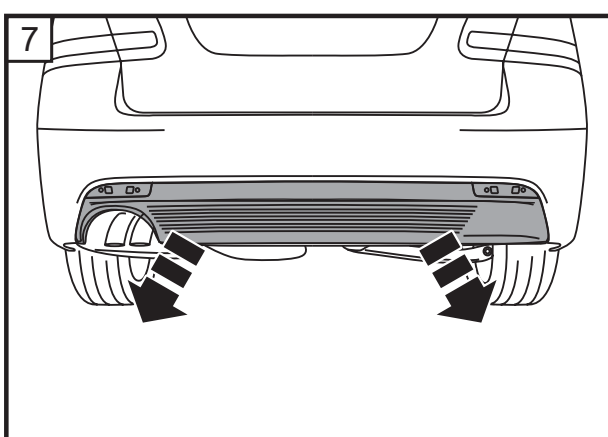
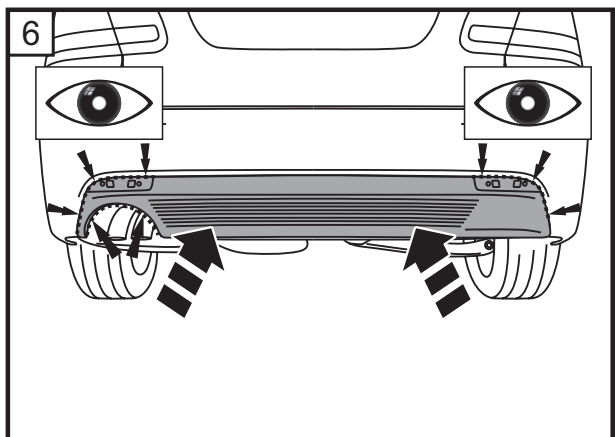
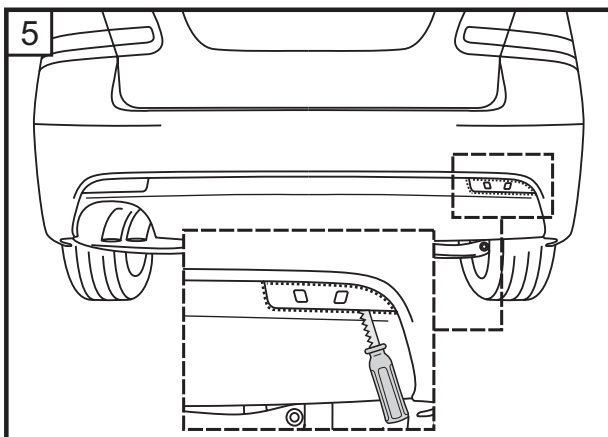
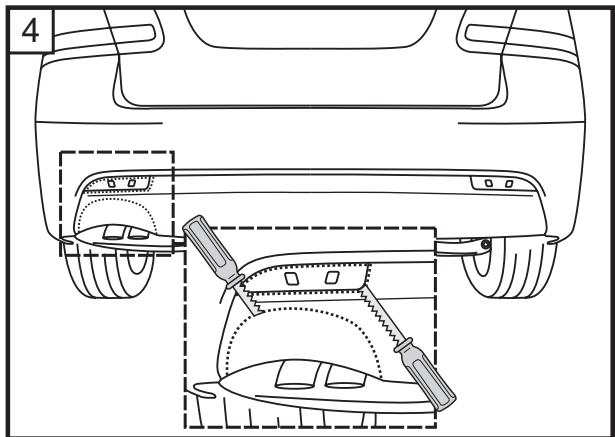
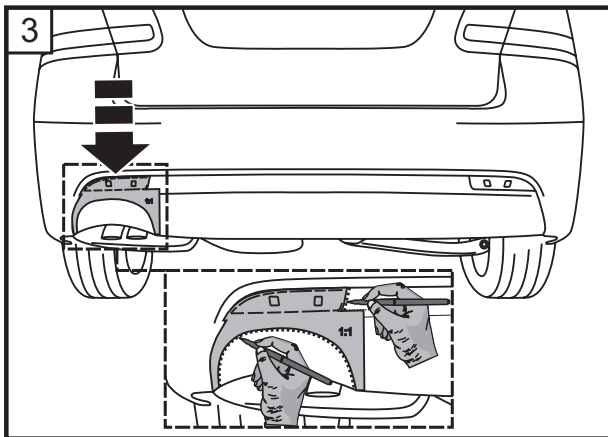
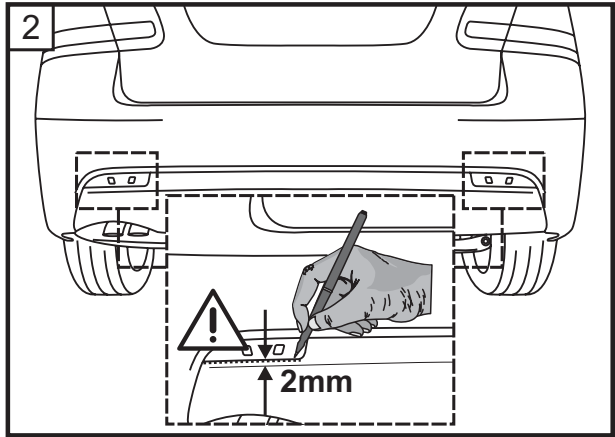
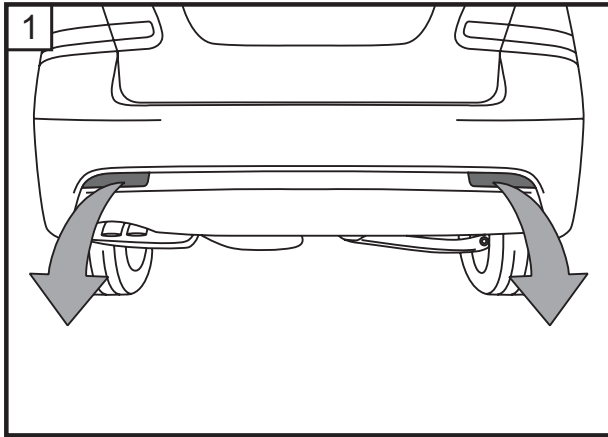

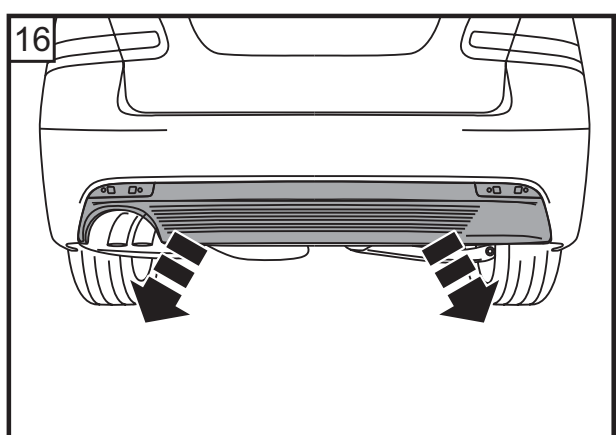
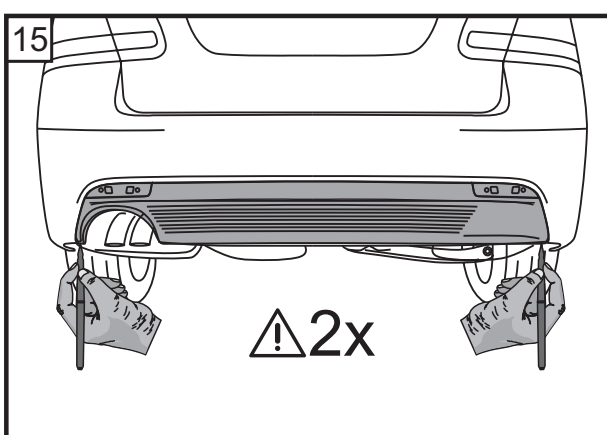
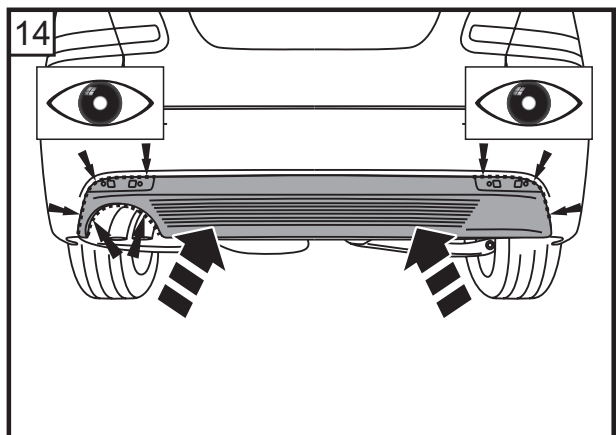
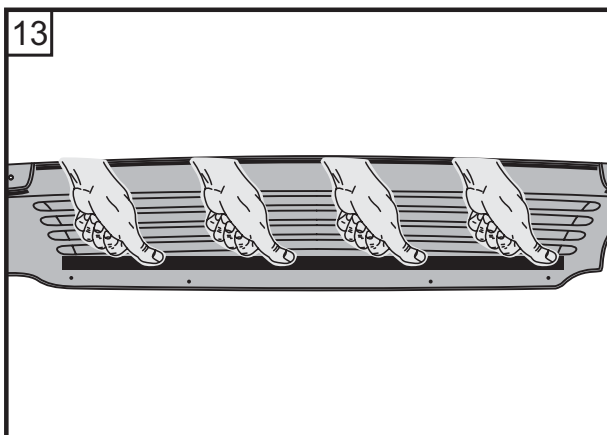
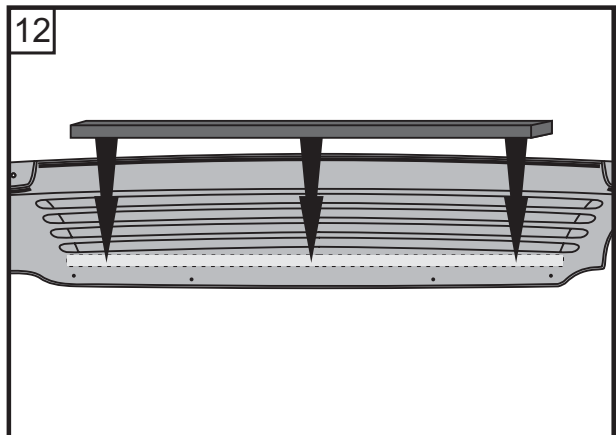
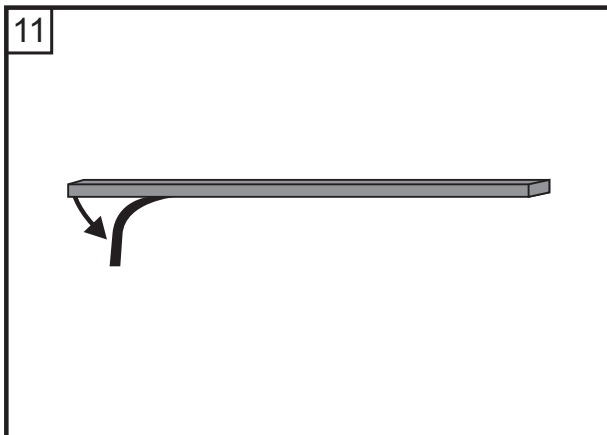
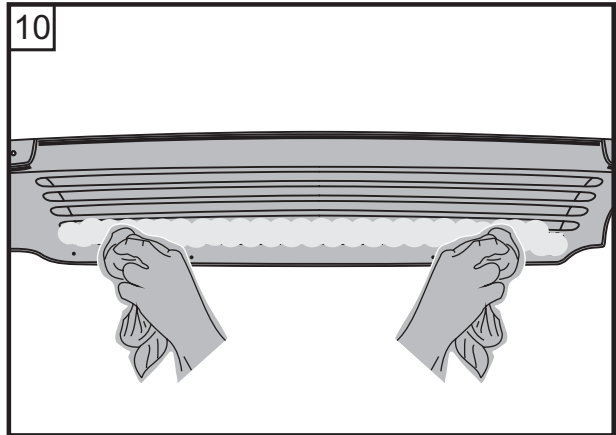
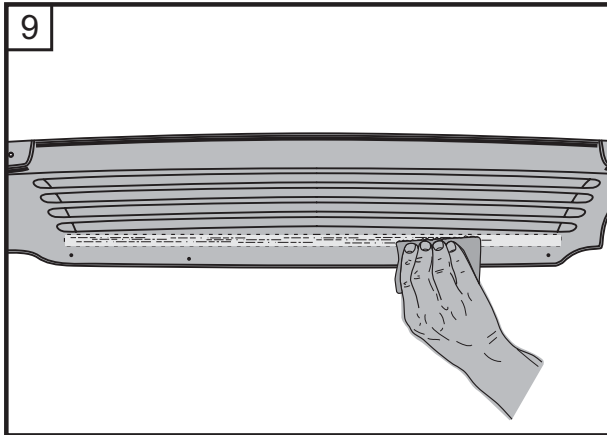

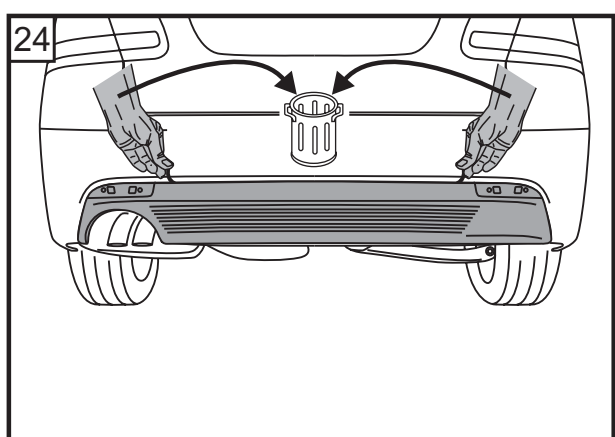
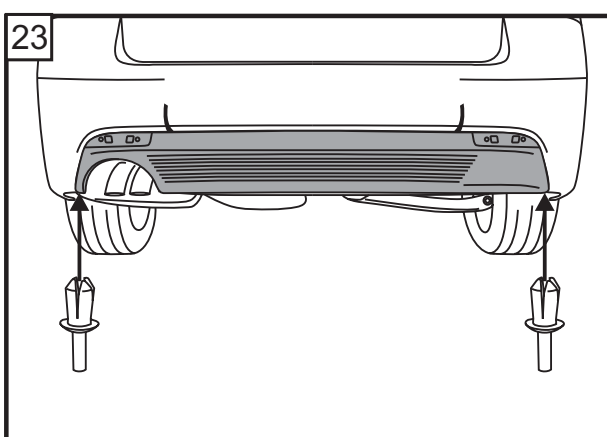
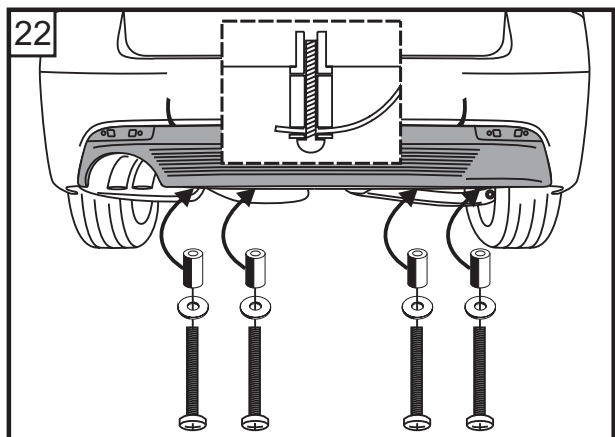
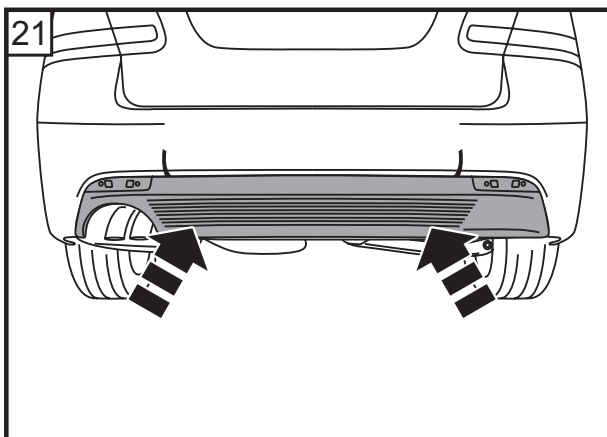
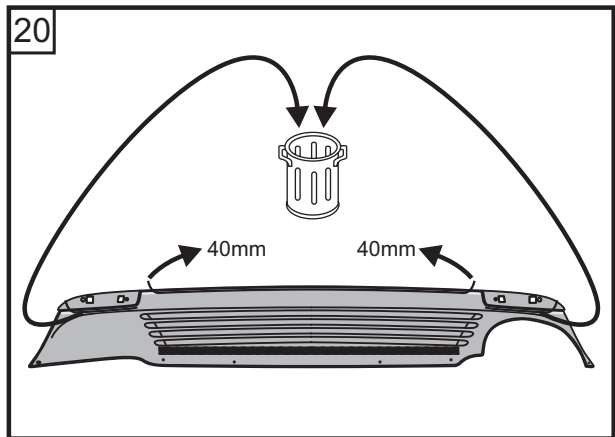
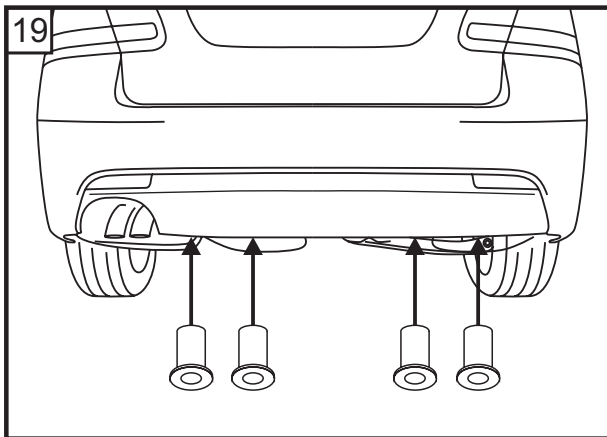
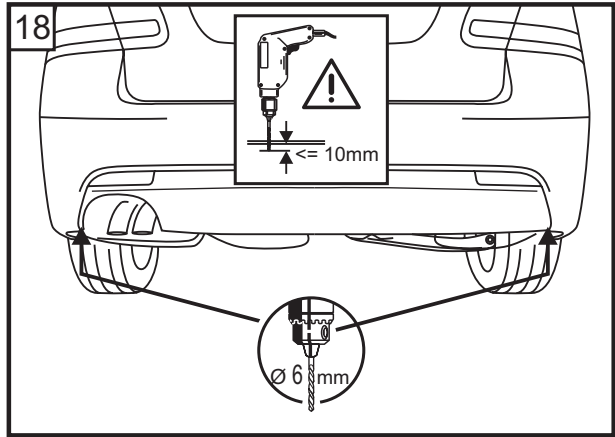
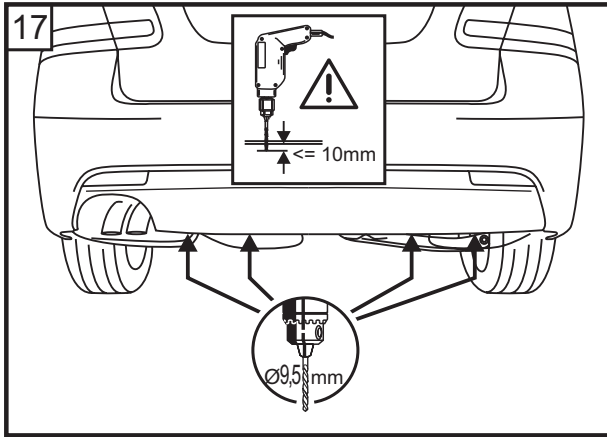

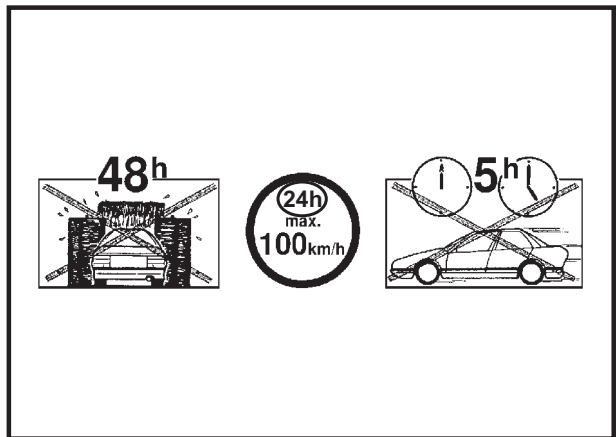
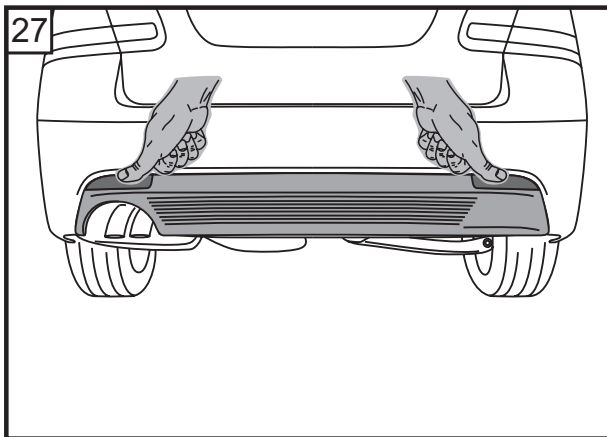
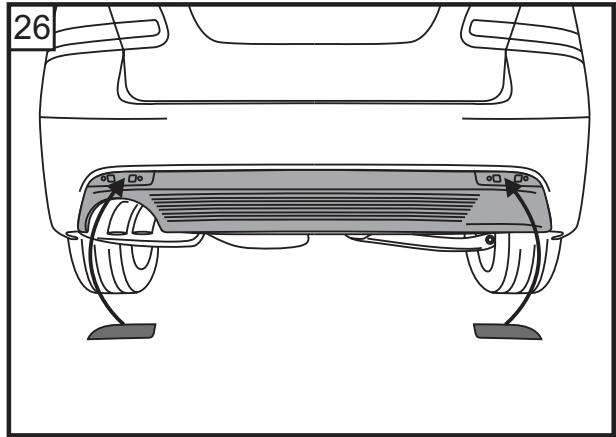
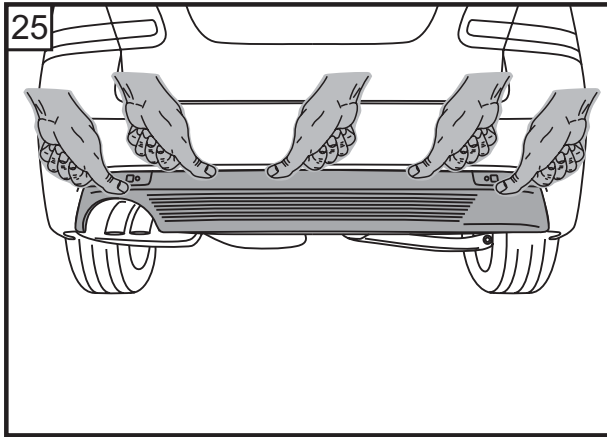





Lackeringsinstruktioner för grundlackerade delar.

SV		Slipa grundlackerade delar jämt (P800-P1000). Undvik att slipa igenom grundlackeringen.
		Kontrollera att det inte finns några ojämnheter, reparera dem och slipa jämt (P800-P1000). Grundera genomgående ställen med en lämplig plastprimer.
		Rengör noggrant med silikonborttagning.
		Det är viktigt att delen som ska lackeras är ordentligt fastsatt vid lackeringen (risk för vridning)! Lägg på lacken enligt tillverkarens anvisningar; tillsatsen av elasticitetsmedel som specificeras av tillverkaren är särskilt viktig. Materialbeteckningen hittar du i delens inre (>.....<, t.ex. >PUR-MF15<).
		Utsätt inte lacken för värme (max. 40°C)!